

CRACK PITTS XL

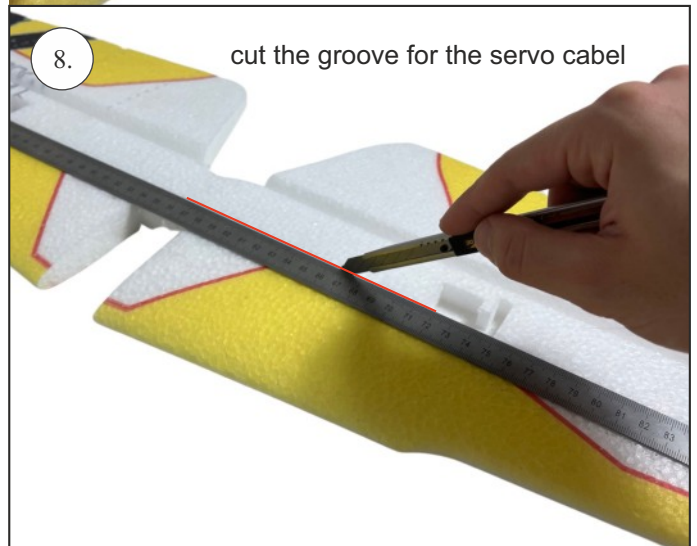

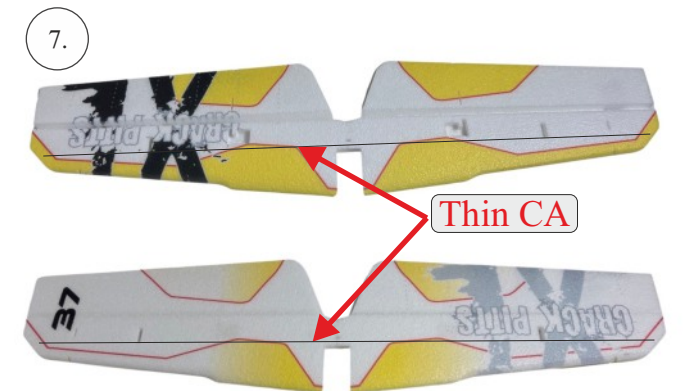

Do the same on the both wings

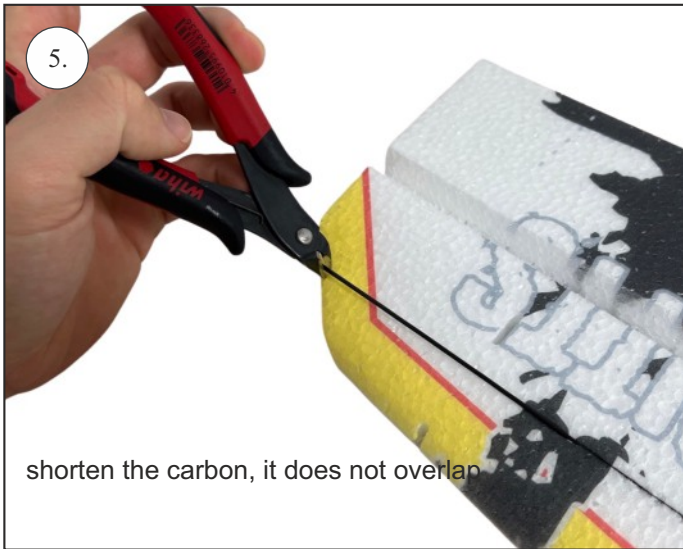
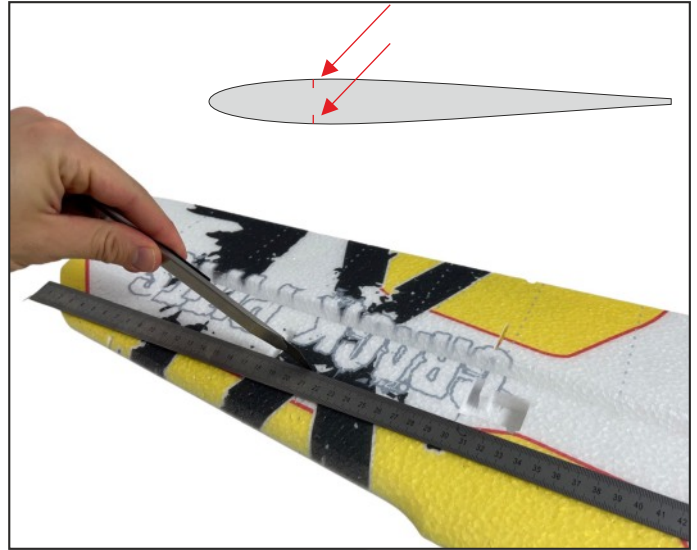
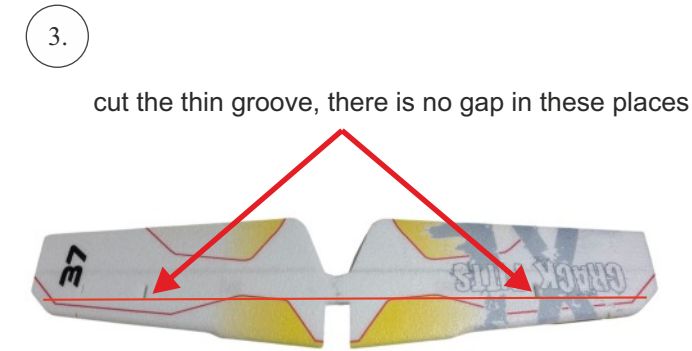
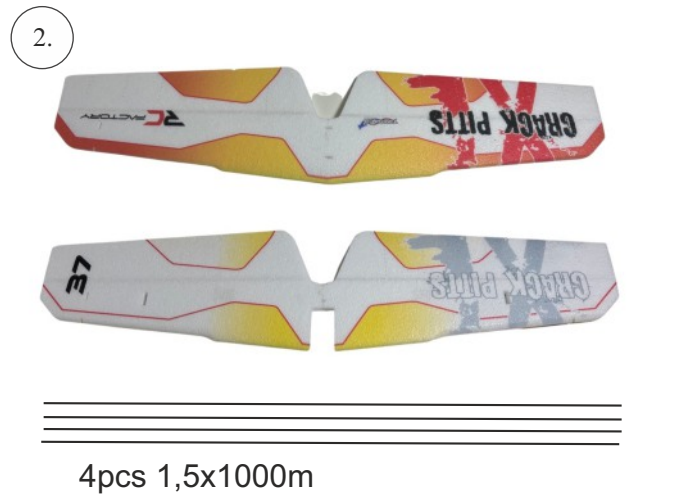
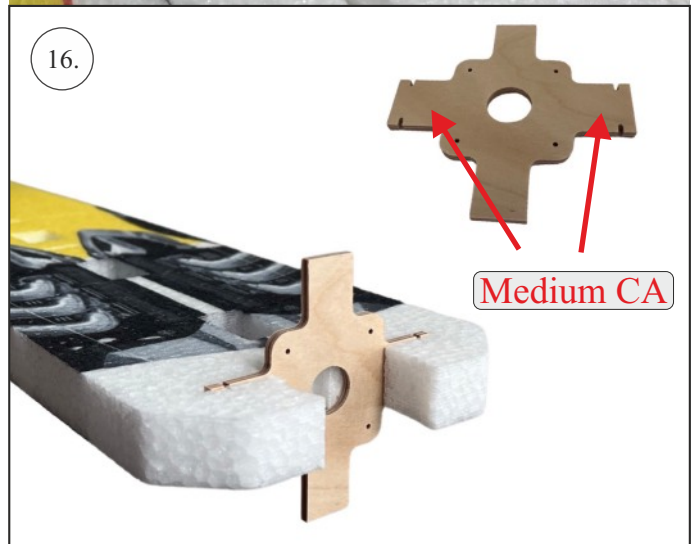
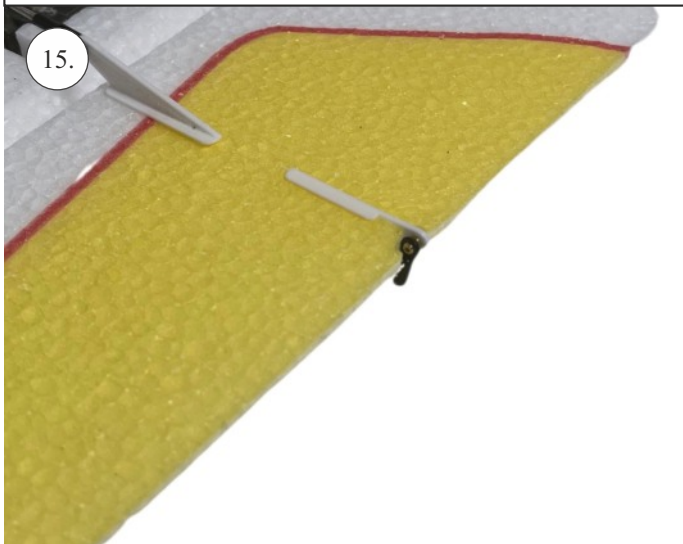
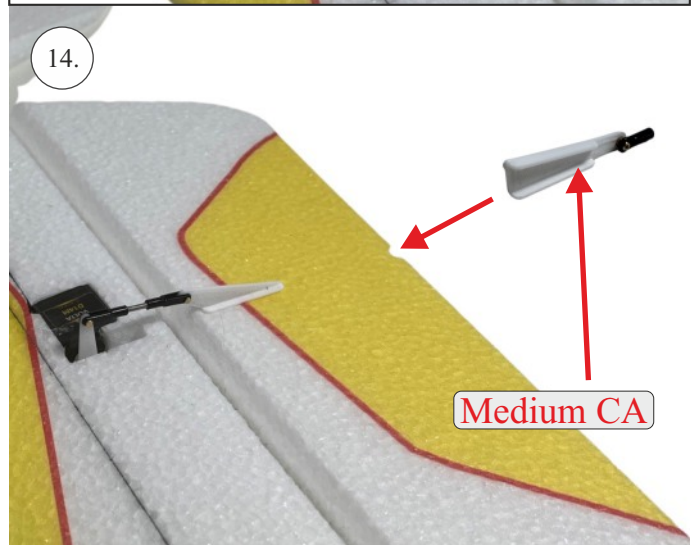
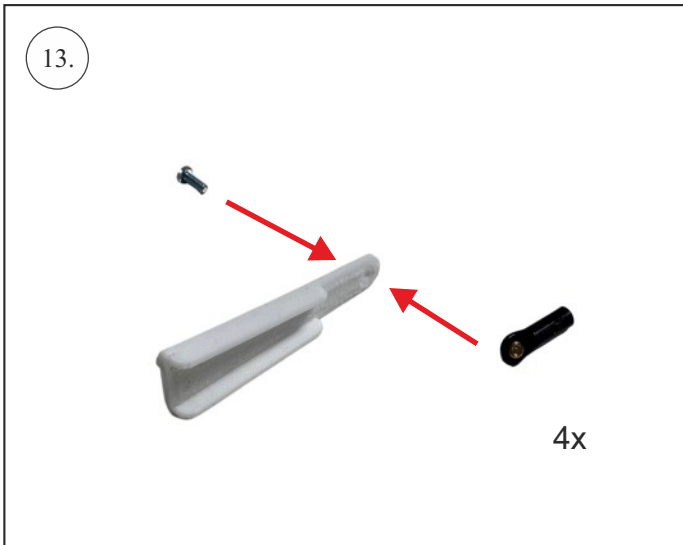
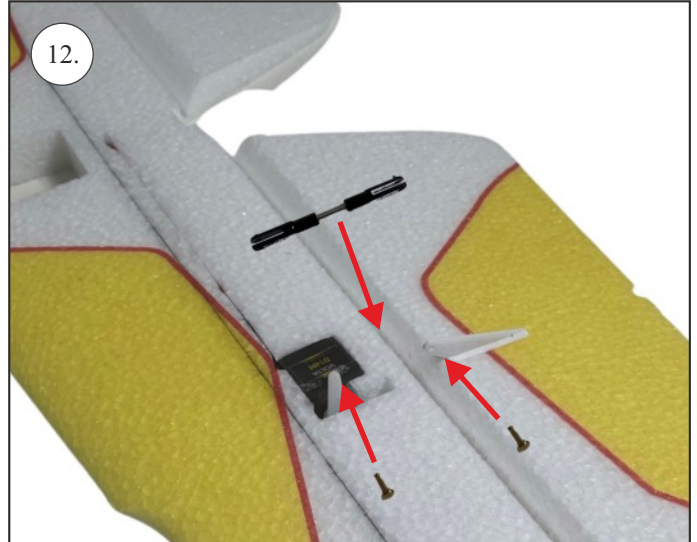
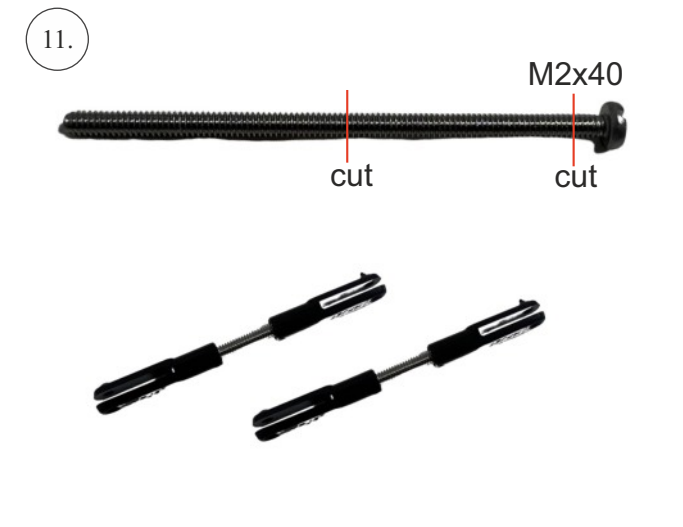

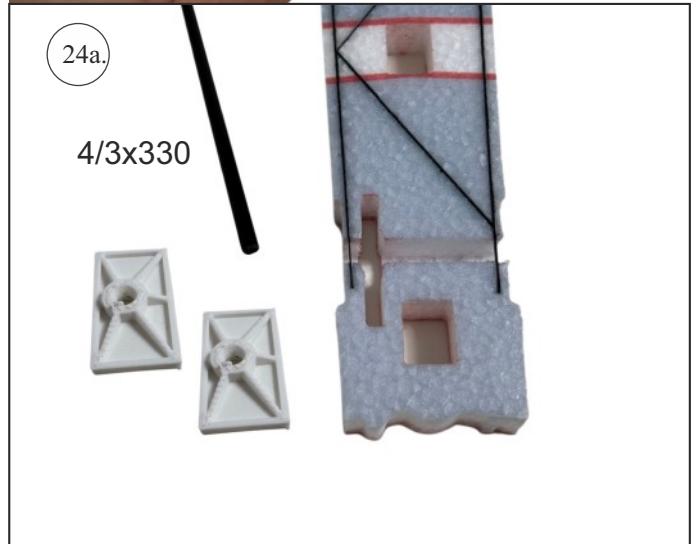
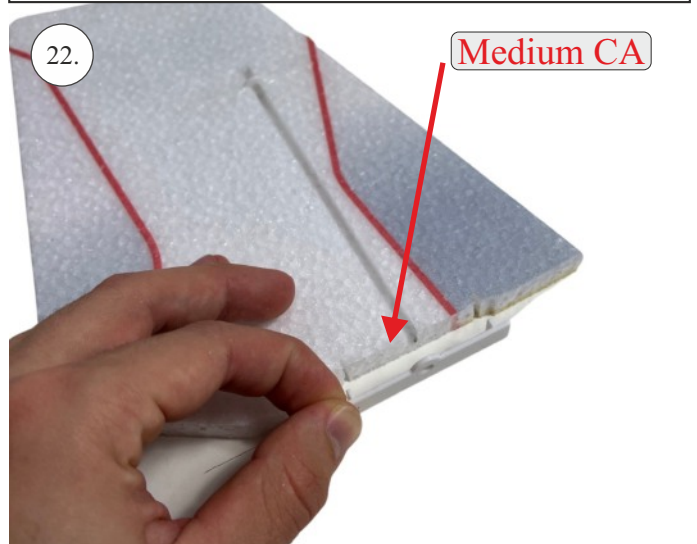
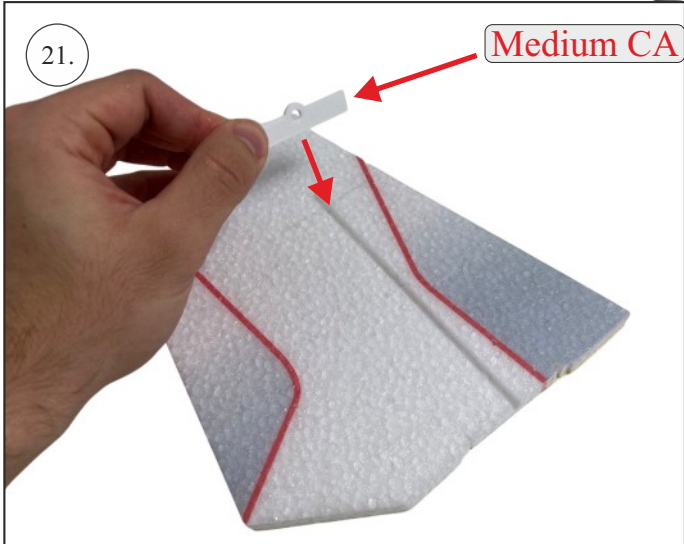
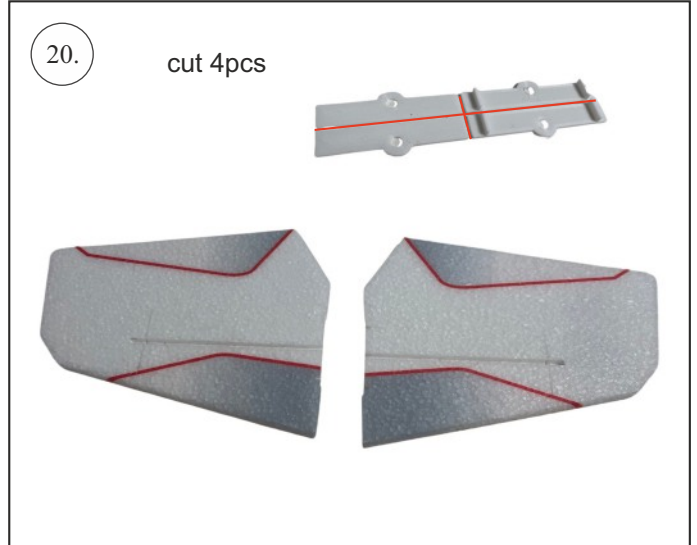
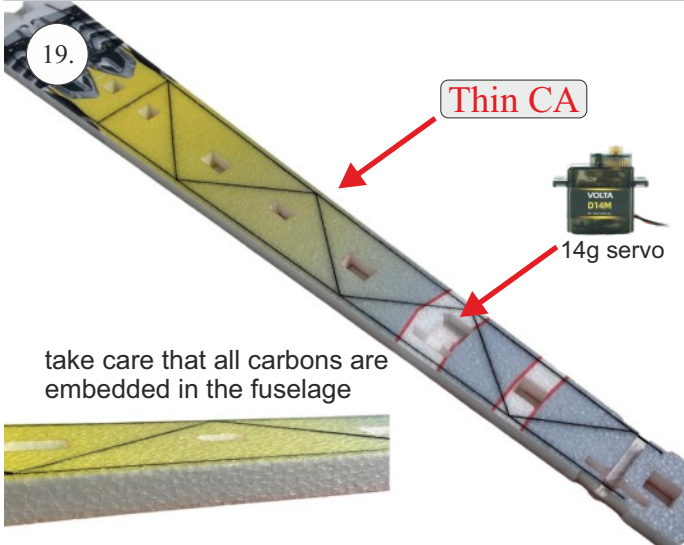
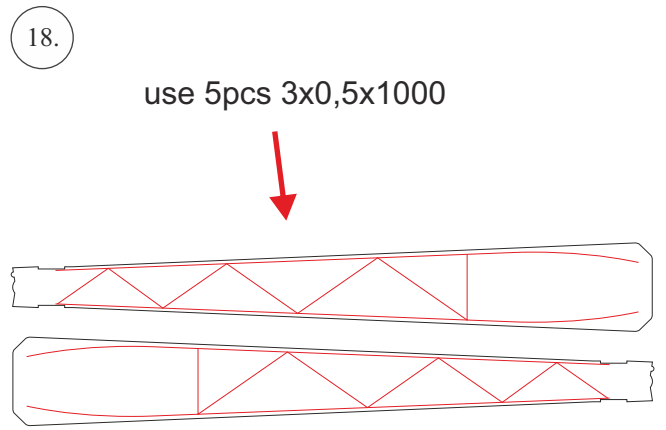
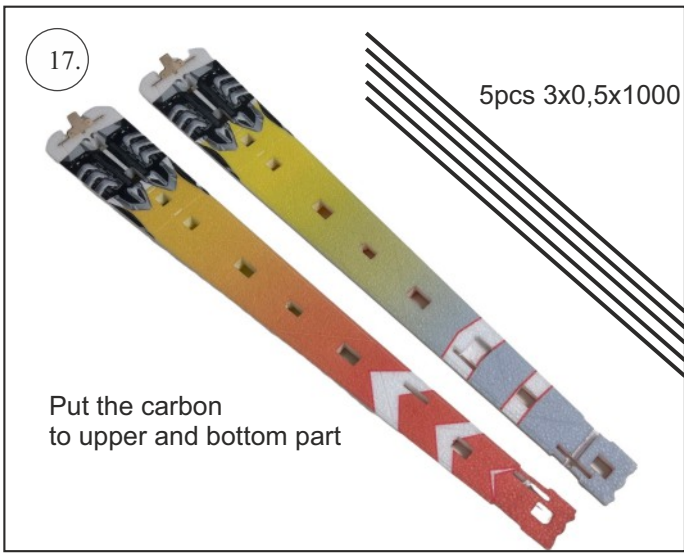

elevators are prepared for the next steps

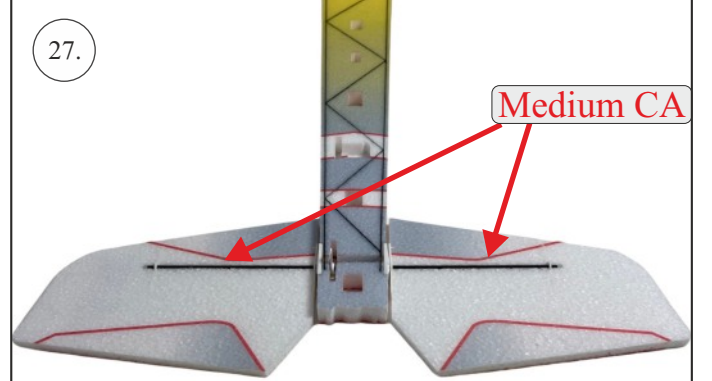
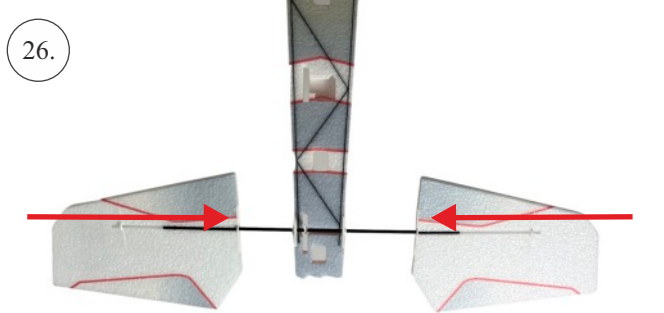
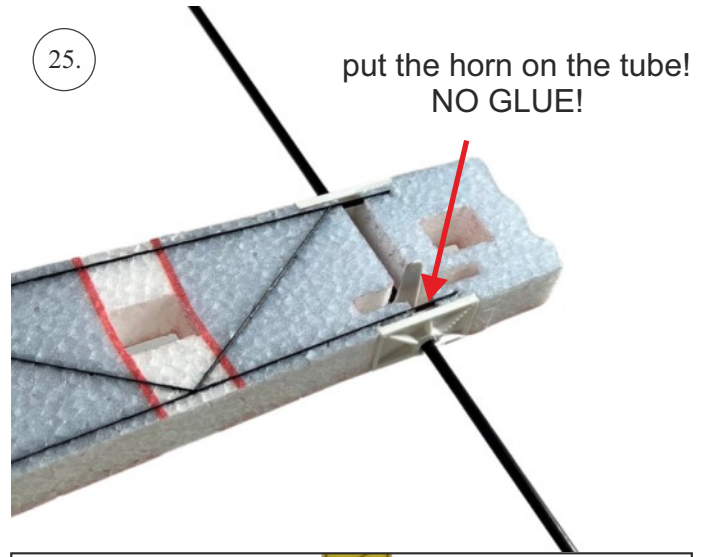
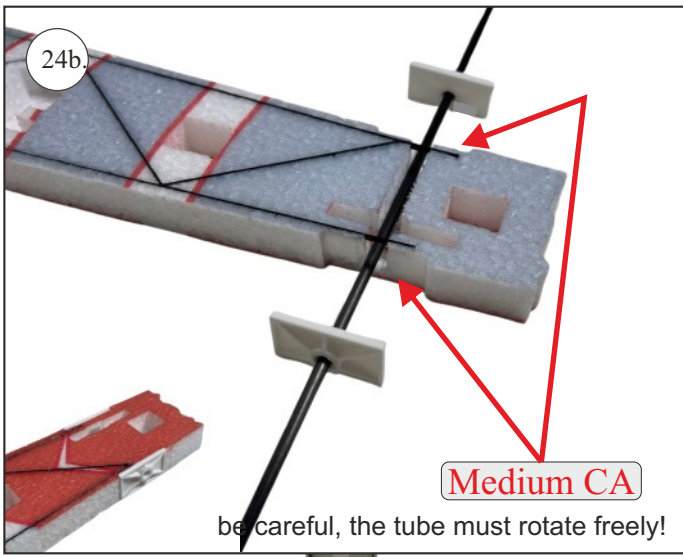

Be careful, both elevators must be the same angle!

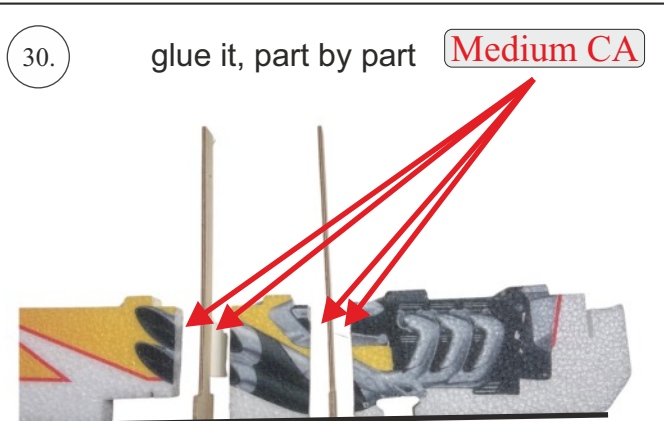
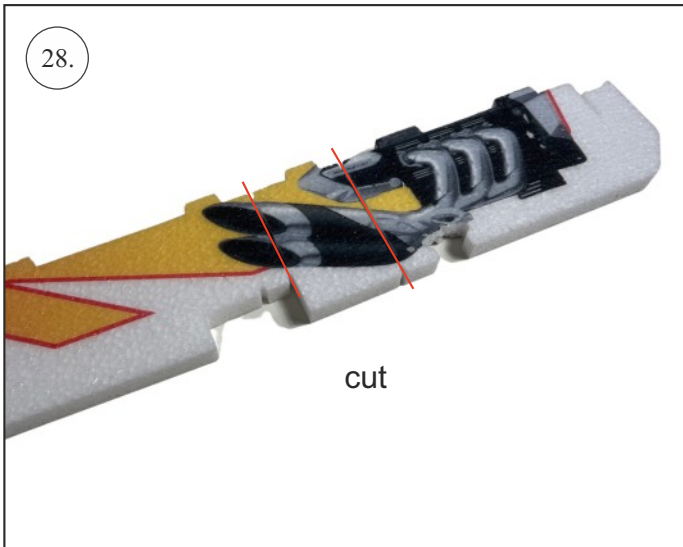

all parts must be in the same line!

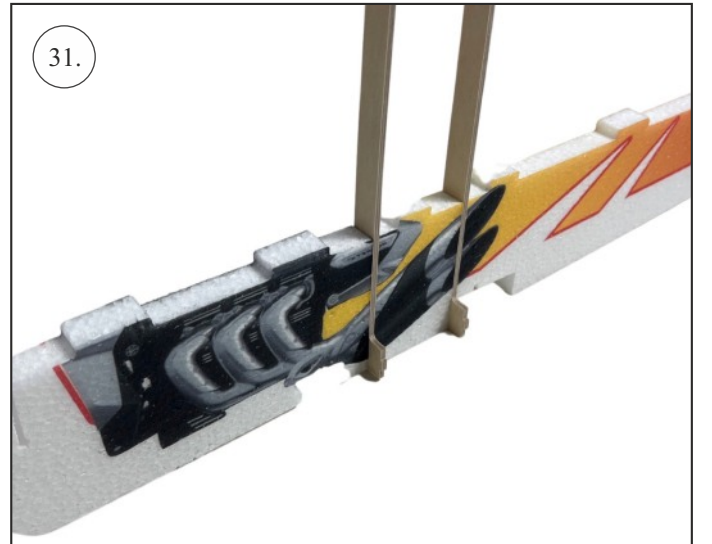

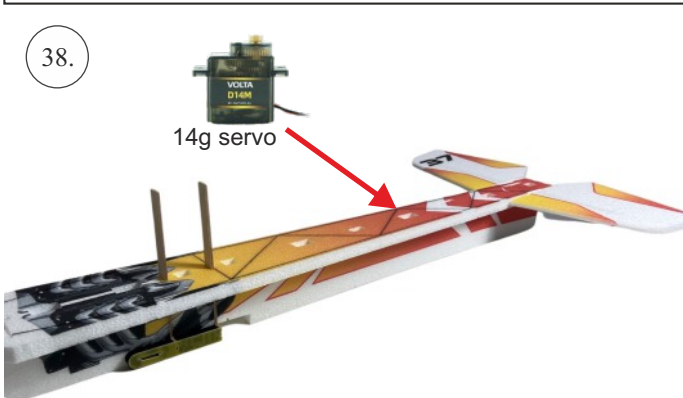
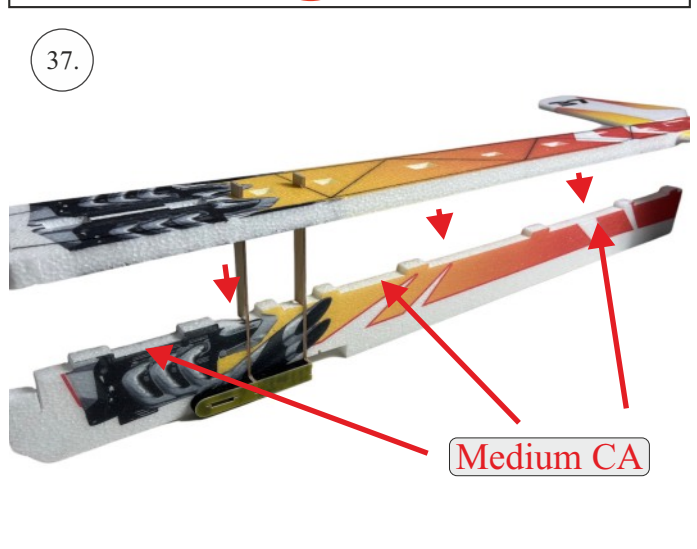
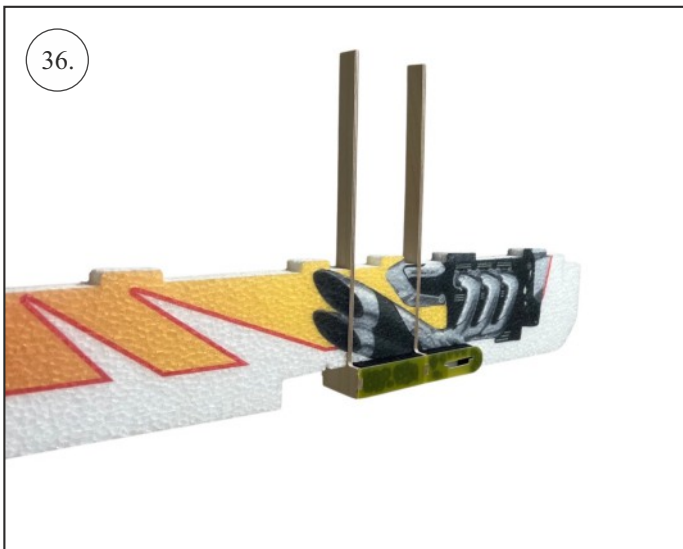
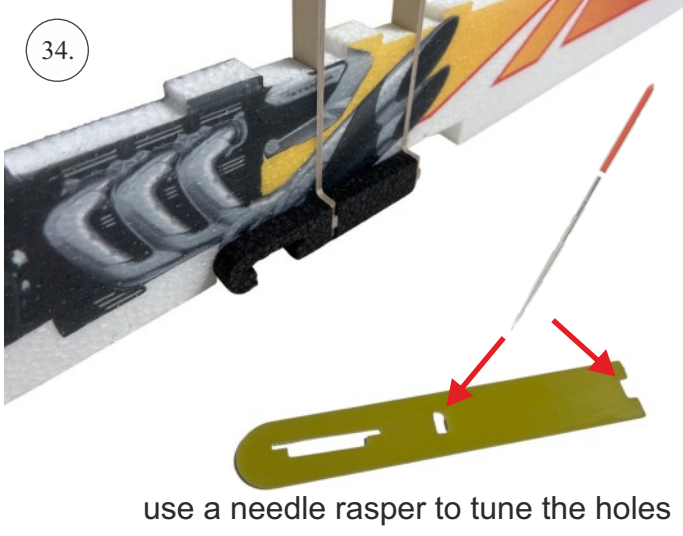
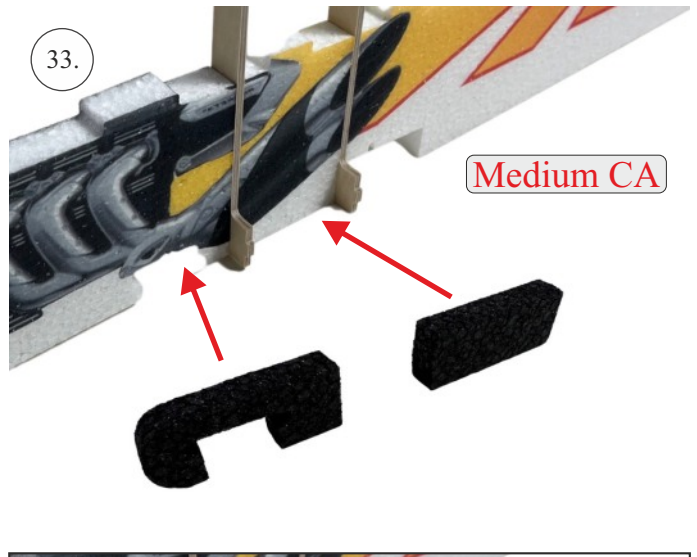
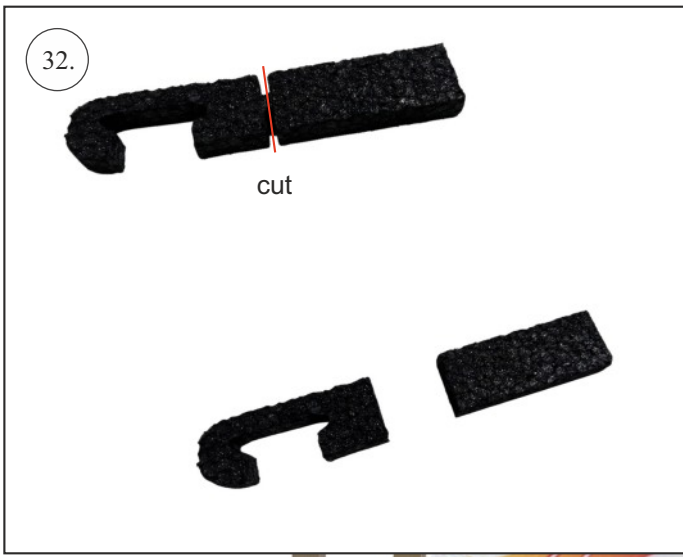

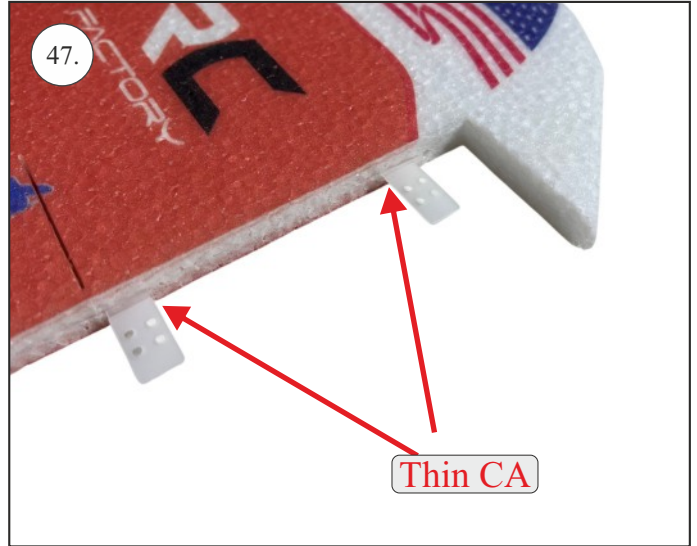
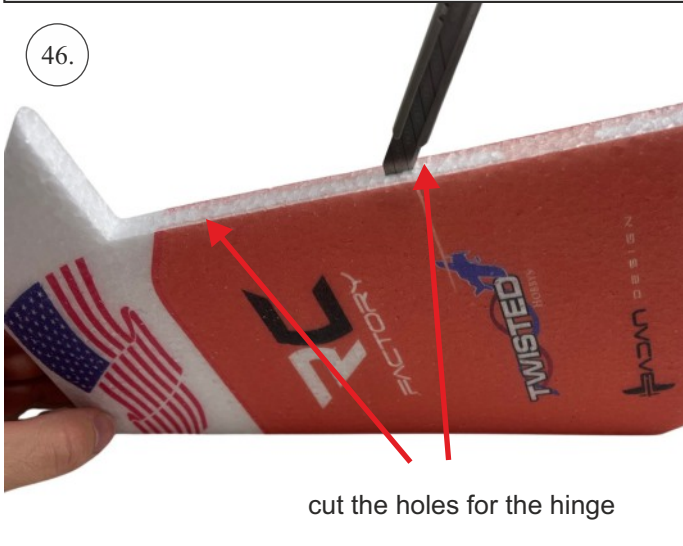
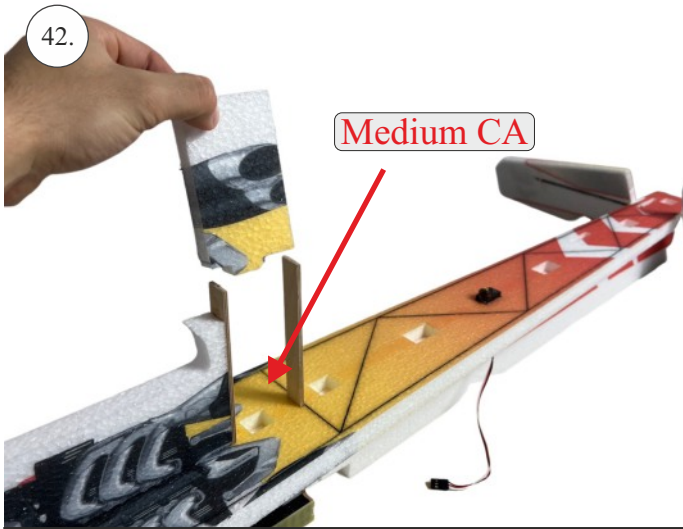
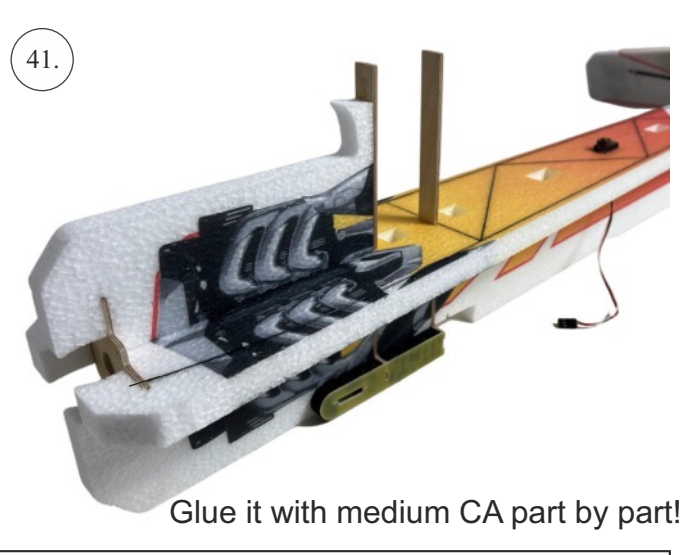
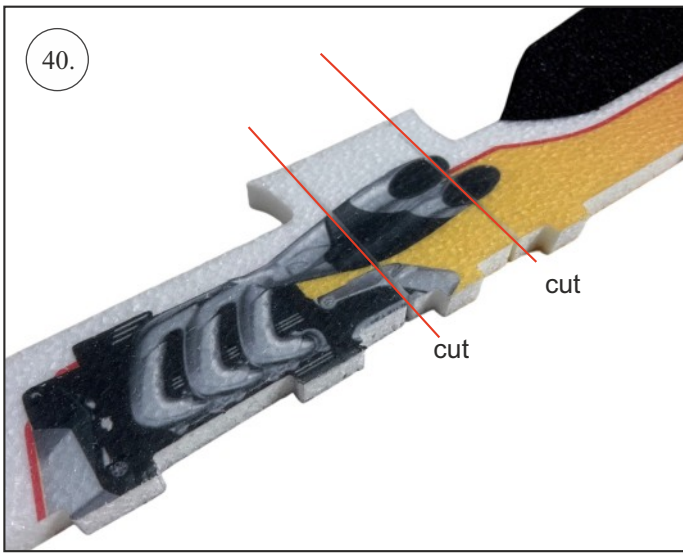

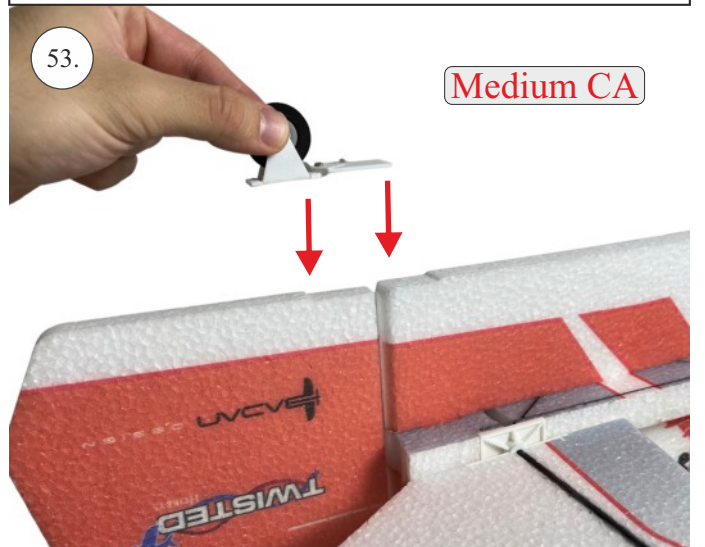
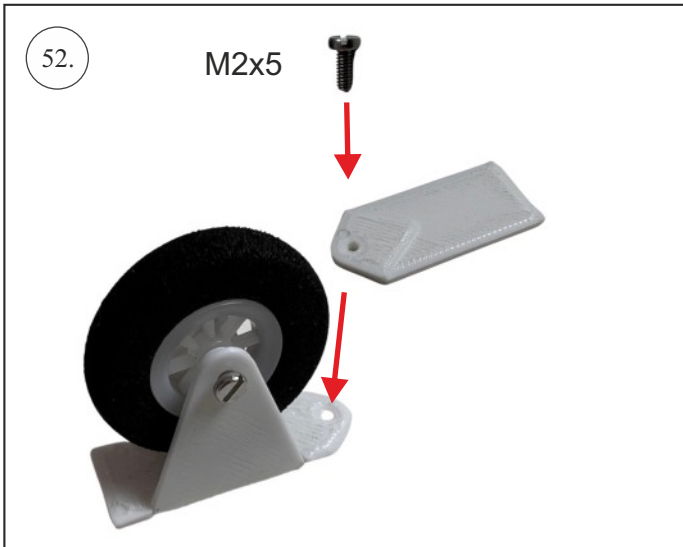
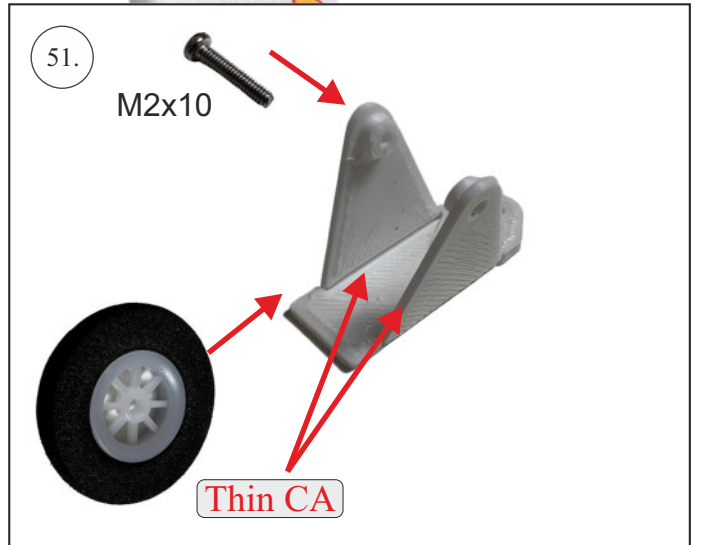
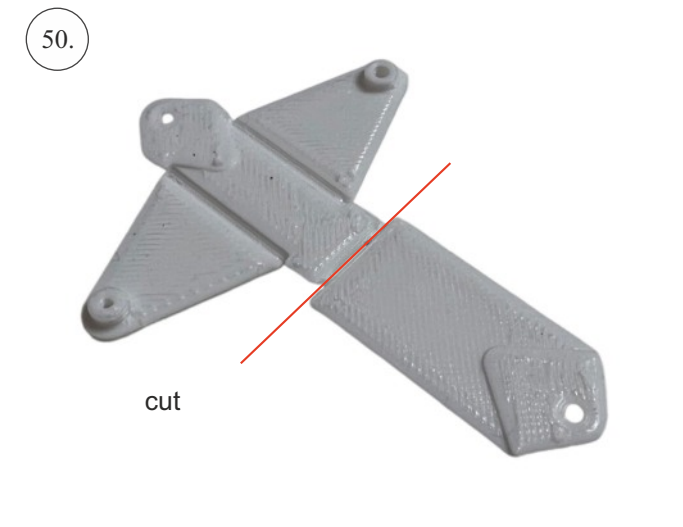
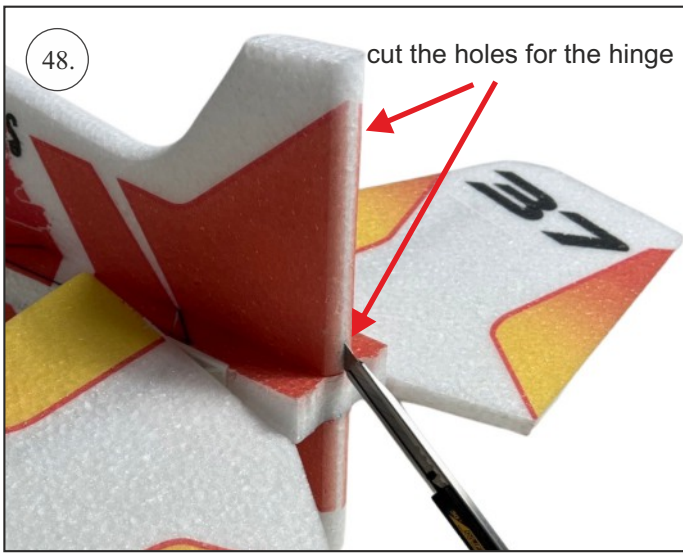

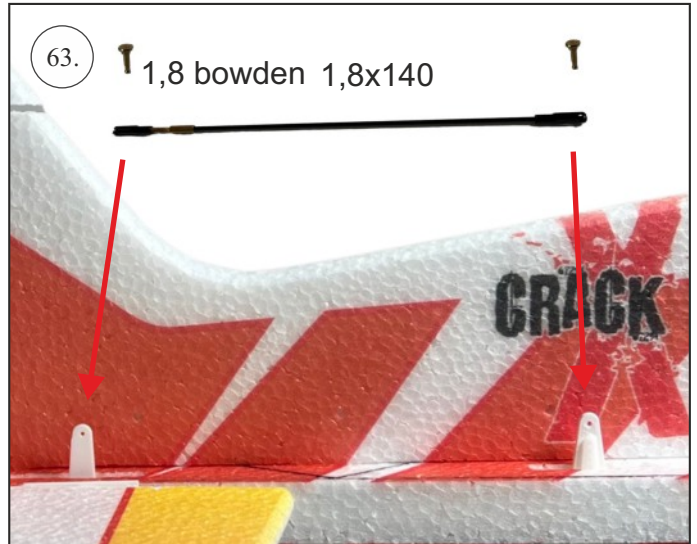
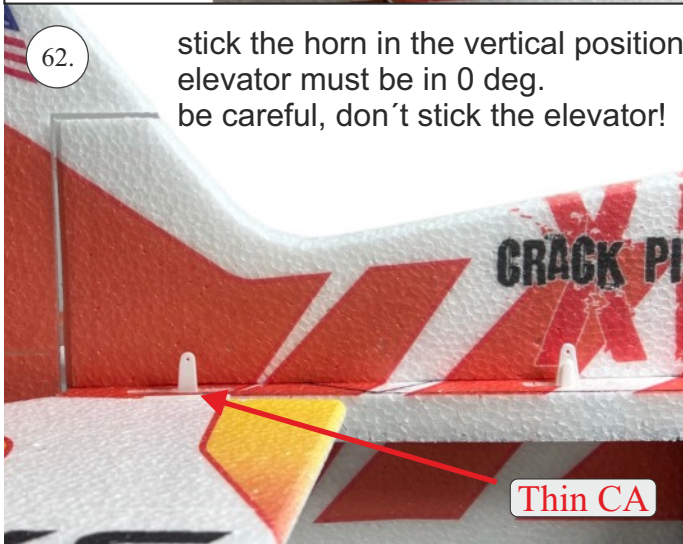
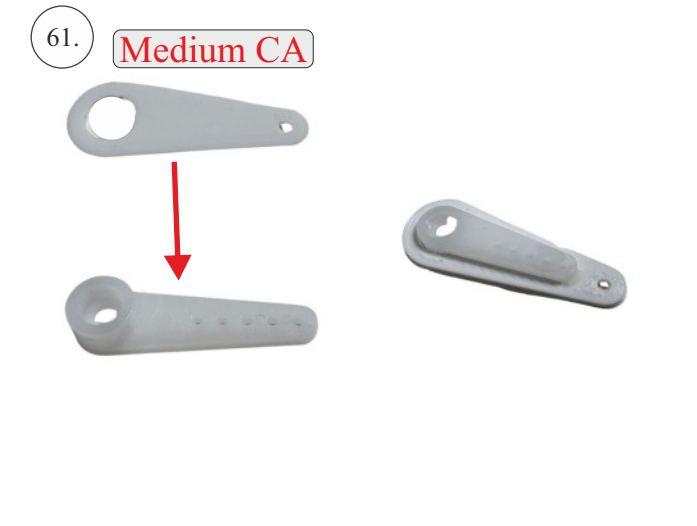
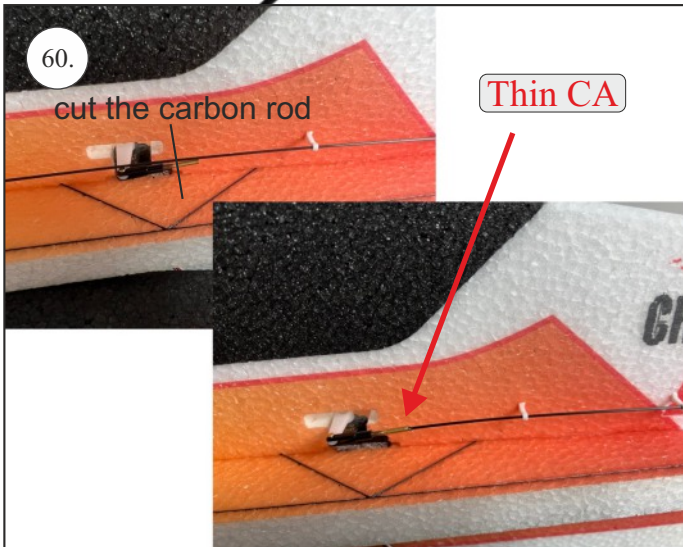
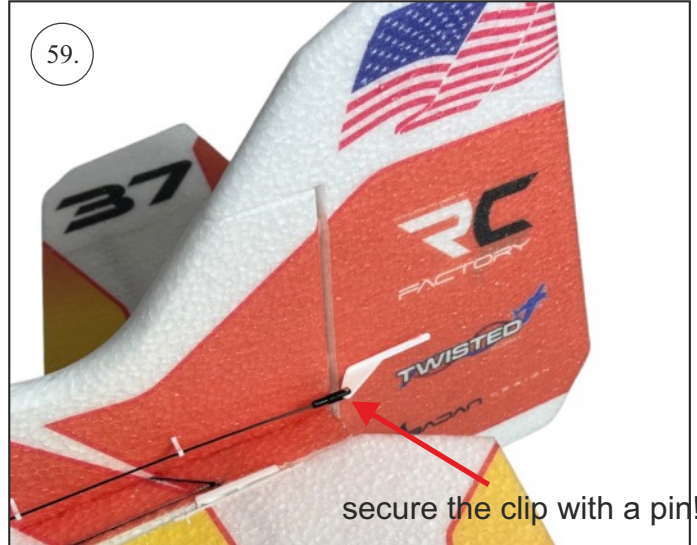
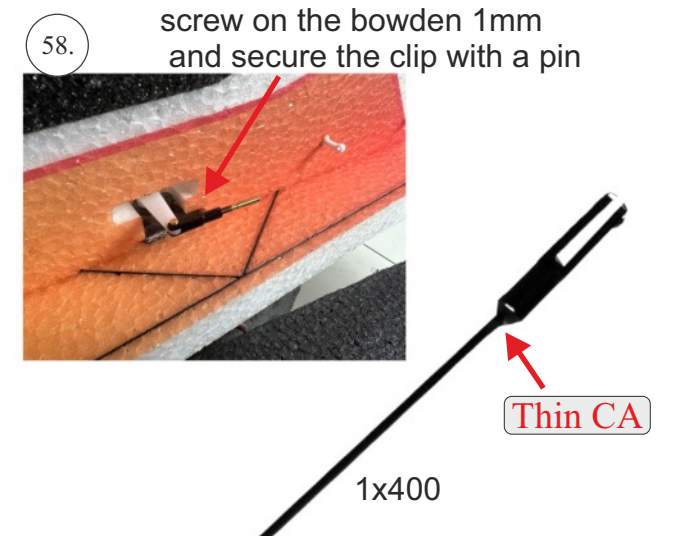
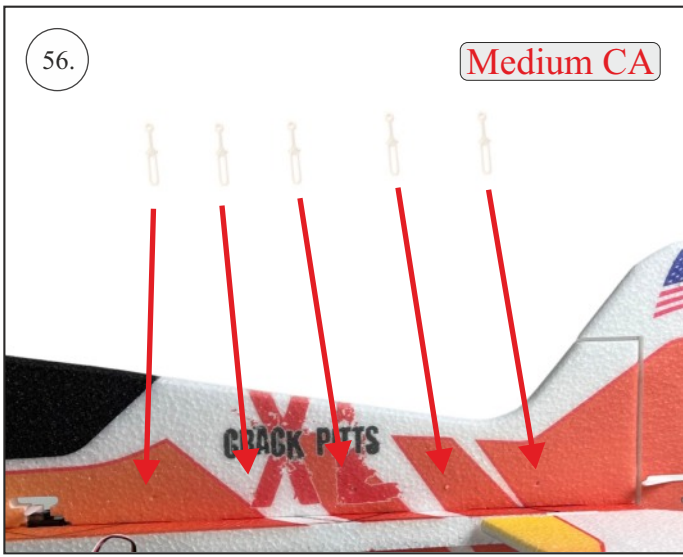

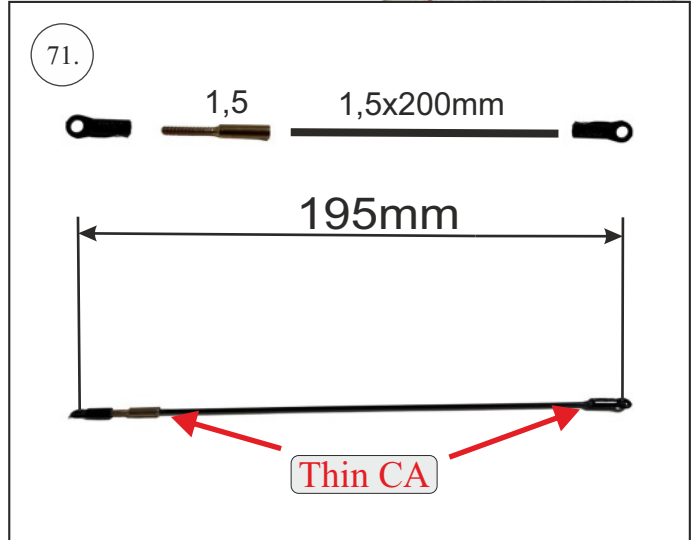
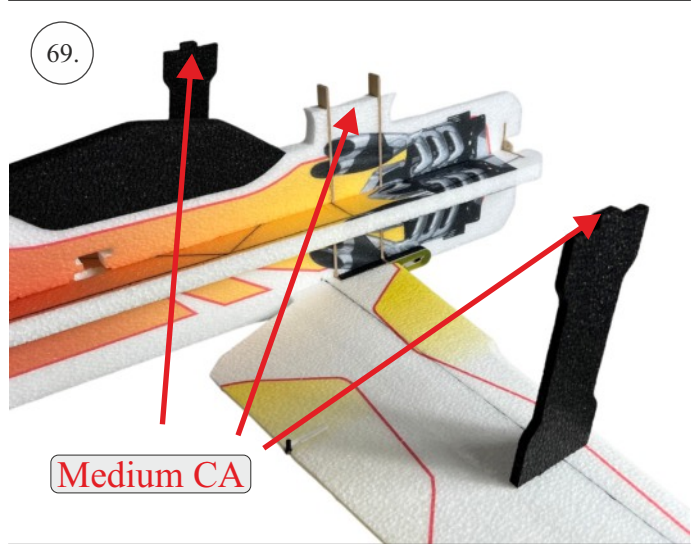
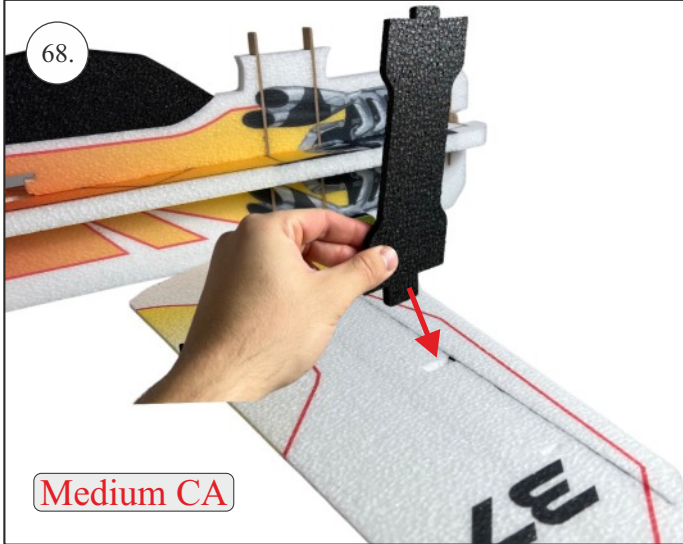
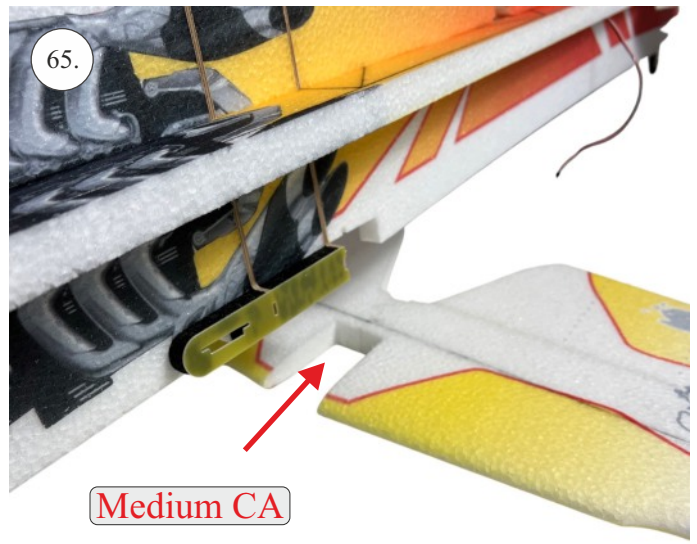
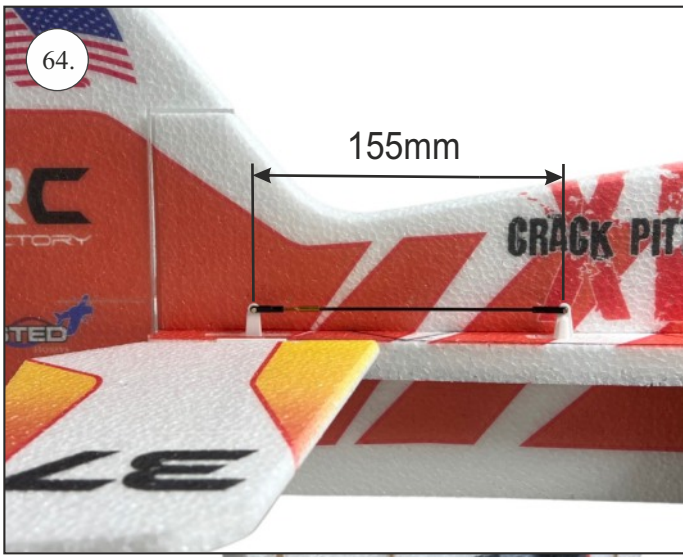

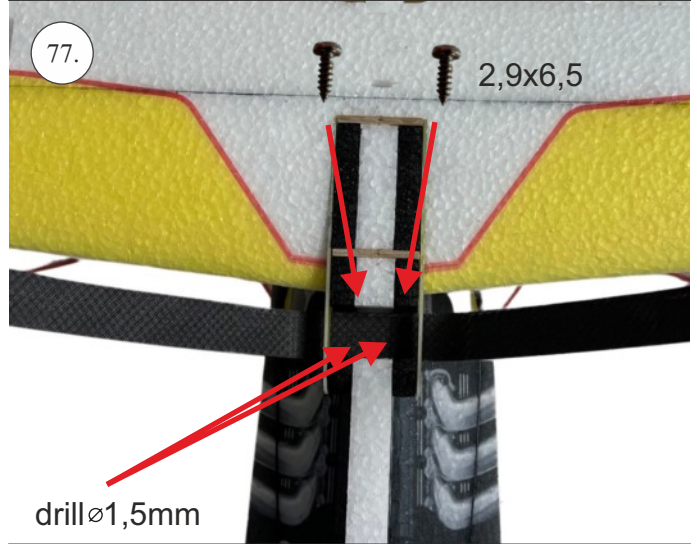
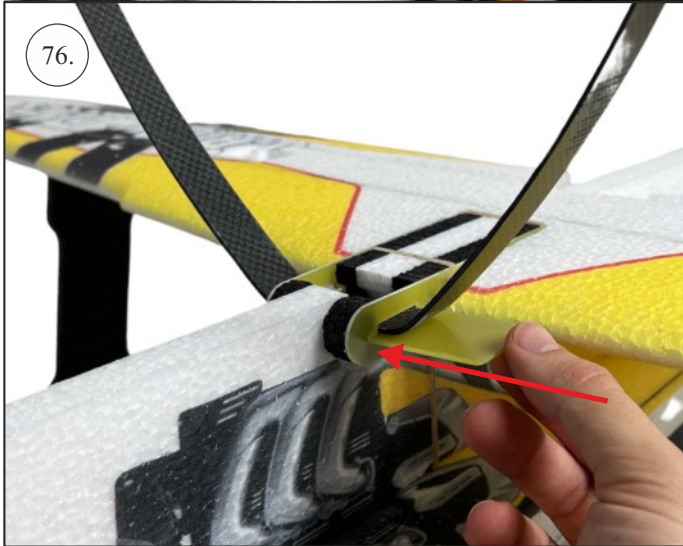
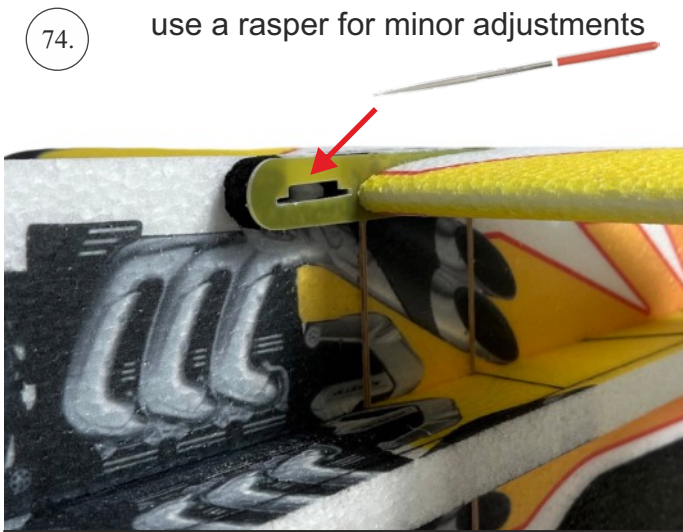
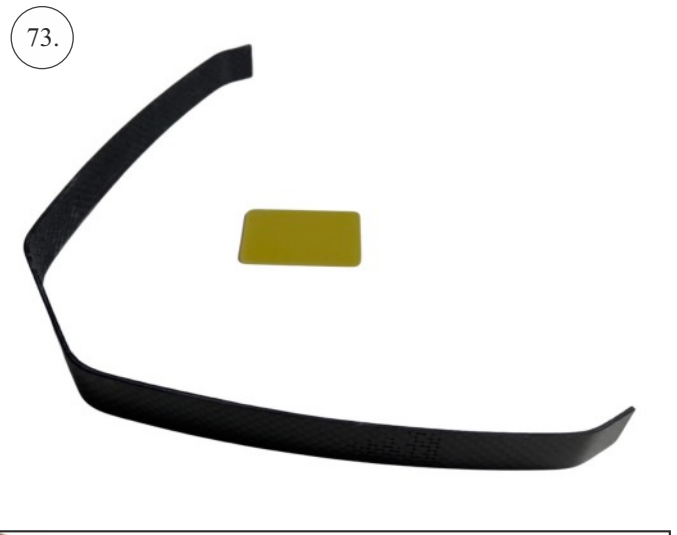
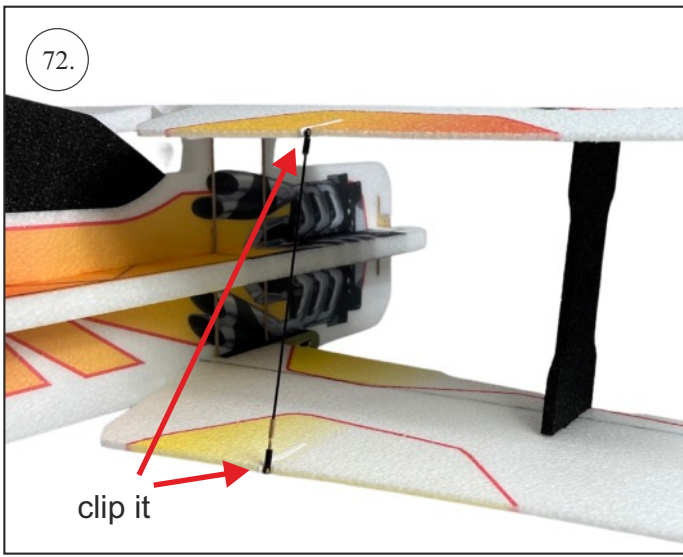

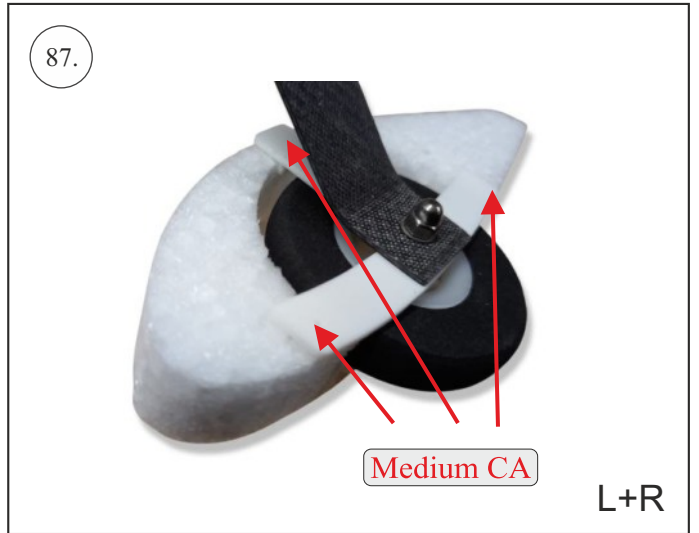
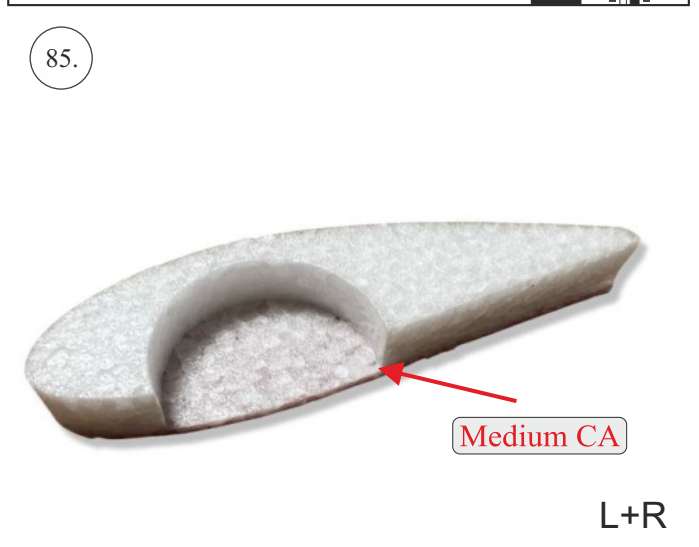
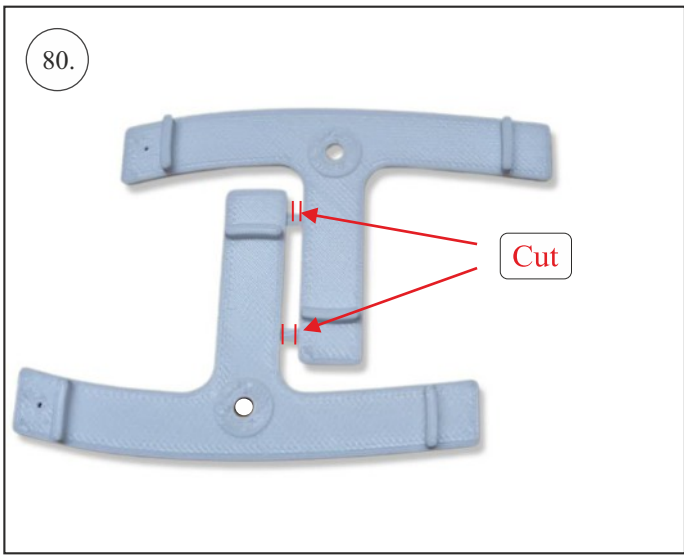

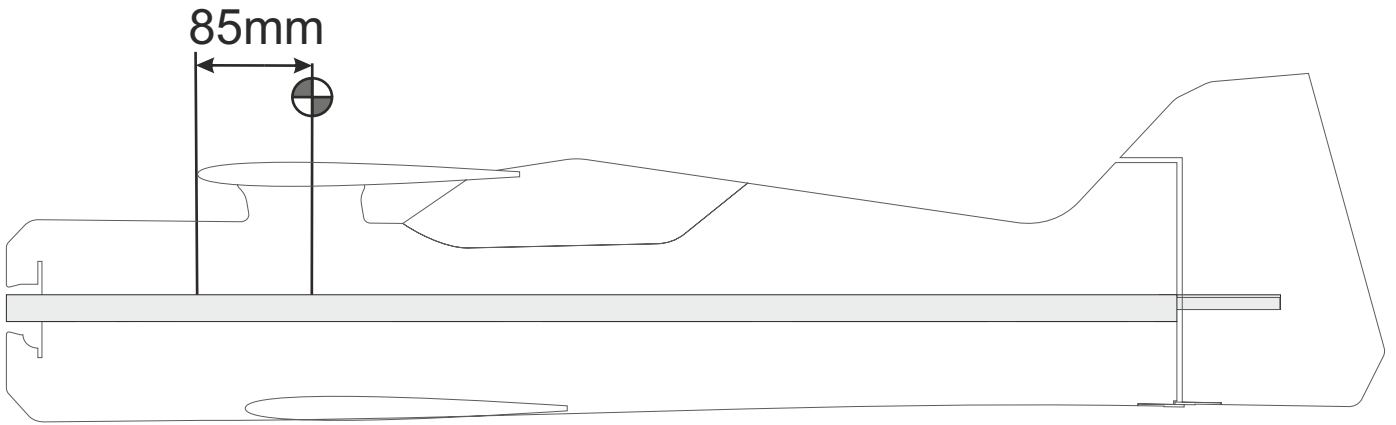

We wish you many happy flying hours with the Crack Pitts XL.

Your RC Factory team