

# ZR30

## 4K AI 180X HYBRID ZOOM OPTICAL POD USER MANUAL



**V1.1**

**Mar 2023**

Thank you for purchasing SIYI's product.

ZR30 is the first SIYI gimbal with quick release structure. Up to 180X hybrid zoom and 30X optical zoom, carrying a 4K 1/2.7-inch Sony CMOS, coming with powerful AI identify and tracking based on neural network processing unit, and 4K video recording and photography, Ethernet and HDMI output are compatible with both SIYI links and third-party links. ZR30's industry-level 3-axis stabilizing technology and high-precision FOC control algorithms ensure stable imaging and zooming ability during flight. HDR and starlight night vision feature can extend the application of gimbal camera in both day and night. ZR30 is a rare and good payload for multi-rotors, VTOLs, and robotics.

To ensure you a good experience of the product, please read this manual carefully. If you encounter any issue using the product, please consult the manual or check the online pages of this product on SIYI official store (<https://shop.siyi.biz>). You can also write an email to SIYI official A/S center ([support@siyi.biz](mailto:support@siyi.biz)).

## SIYI User Group - Facebook



SIYI Official Store (<https://shop.siyi.biz>)

SIYI Official AliExpress Store (<https://siyi.aliexpress.com>)

SIYI YouTube Channel (<https://www.youtube.com/c/SIYITech>)

**CONTENT**

READ TIPS..... 1

    Icons..... 1

    Safety ..... 1

    Storage / Carrying / Recycling ..... 2

1 INTRODUCTION ..... 3

    1.1 Product Features ..... 3

    1.2 Parts..... 6

        1.2.1 At a Glance..... 6

        1.2.2 Pinouts..... 9

    1.3 Technical Specification..... 10

    1.4 Packing List..... 12

    1.5 Indicator Definition ..... 13

2 GET READY TO USE ZR30..... 14

    2.1 Installation ..... 14

    2.2 Connection and Power..... 15

3 GIMBAL CONTROL ..... 16

    3.1 Control Gimbal Camera from SIYI FPV App or SIYI QGC on SIYI Handheld Ground Station ..... 16

        3.1.1 Preparation..... 16

        3.1.2 Gimbal Pitch and Yaw Rotation..... 18

        3.1.3 Zoom and Focus..... 18

        3.1.4 Take pictures and Record Video ..... 19

    3.2 Control Gimbal through S.Bus Signal (Taking an Example of MK15)..... 19

        3.2.1 Preparation..... 20

        3.2.2 Gimbal Pitch and Yaw Rotation (Taking an Example of MK15 Dials)..... 22

        3.2.3 Zoom and Focus (Taking an Example of MK15 Switches) ..... 23

        3.2.4 Take Pictures and Record Video (Taking an Example of MK15 Buttons) ..... 24

    3.3 UART / UDP Control (through SDK) ..... 25

        3.3.1 SDK Protocol Format ..... 25

        3.3.2 SDK Communication Commands..... 25

        3.3.3 ZR10 SDK Communication Interface..... 31

        3.3.4 ZR10 SDK Communication Code Examples..... 31

3.3.5 SDK CRC16 Code .....	33
4 VIDEO OUTPUT .....	35
4.1 Output and Display Video on SIYI Handheld Ground Station.....	35
4.2 Output Video Stream through HM30 Full HD Image Transmission System.....	35
4.3 Output Video to Third-Party Link.....	37
4.4 Output by HDMI .....	38
4.5 Solutions to No Image .....	39
4.5.1 Video Output to Android Device .....	39
4.5.2 Video Output to Windows Device.....	41
4.6 Common IP Addresses .....	42
5 SIYI FPV APP .....	43
5.1 Settings.....	45
5.2 Link Status.....	46
5.3 Gimbal Camera.....	47
5.4 About SIYI FPV.....	48
6 Firmware Upgrade and Configuration .....	49
6.1 Gimbal / Zoom Firmware Update .....	49
6.2 Camera Firmware Update.....	52
6.3 Gimbal Camera Configuration .....	54
6.3.1 Channel Settings .....	54
6.3.2 Camera Specs .....	55
7 After-sale Service .....	57
7.1 Repair Service.....	57
7.2 Warranty .....	58
7.2.1 7-Day Return & Refund.....	58
7.2.2 15-Day Replacement.....	59
7.2.3 1-Year Warranty Repair .....	61

## READ TIPS

### Icons

Please pay more attention to content indicated with the following marks:

 **DANGER** Dangerous manipulation probably leads to human injuries.

 **WARNING** Warnings on manipulation possibly leads to human injuries.

 **CAUTION** Cautions on what manipulation may lead to property loss.

 **Prohibited**    **Mandatory**    **Mark**

### Safety

ZR30 optical pod is designed for professional application in specific scenes, which has been done necessary configuration before delivery, it is forbidden to disassemble the gimbal or to change its mechanical structure. And don't add more payload to the gimbal other than its own camera. Gimbal camera is designed with very precise structure, users who approach to the equipment should have the basic knowledge of how to operate it. Irregular or irresponsible manipulations to the device may cause damage, property loss, or human injuries, and SIYI Technology is not obliged to any of the damage, loss, or injury. It is prohibited to use SIYI products for military purpose. Users under 14 years' old should follow an

experienced trainer's guide. Disassembling or modification to the system is prohibited without permission from its manufacturer, SIYI Technology.

## **Storage / Carrying / Recycling**

When your SIYI products are stand idle, or you are bringing it outdoors, or the system reached service life, then please do read the precautions below.



### **CAUTION**

Always place your SIYI products at places where babies or kids do not reach.



### **DANGER**

SIYI products should be placed in places with below conditions:

Not too hot (above 60°C) or too cold (under -20°C).

Not under direct sunshine or too dusty or too wet.

Not on an unstable holder which lacks solid supports or may cause vibration.

Not nearby steam or other heat sources.

# 1 INTRODUCTION

## 1.1 Product Features

### **180X Hybrid Zoom, 30X Optical Zoom**

ZR30 gimbal camera supports 180x hybrid zoom and up to 30x optical zoom, offering crystal clear and very far view. ZR30's fast and accurate algorithm makes it focus quickly and quite easy to output high-quality videos.

### **AI Smart Identify and Tracking**

Embedded in brand-new AI algorithms developed by SIYI, ZR30 gimbal camera can autonomously identify moving objects like vehicles, boats, and people. Companion with gimbal rotation and UAV flight control system, ZR30 will accomplish an overall smart operation from identifying and locating to continuously tracking. The zoom camera will always maintain the tracking object in the center of the image.

\*The AI feature is under development and can be updated later.

### **Quick Release, Fast Payload Change**

As the first gimbal pod carrying the quick release structure, ZR30 can be changed quickly to meet the requirement of different application scenes. There will be more interesting SIYI payloads joining in the quick release ecology. Welcome to pay an attention.



## **Professional Imaging System**

ZR30 carries a 1/2.7-inch Sony image sensor, a megapixels CMOS with remarkable photosensitivity ability, impressive 4K video recording and photography. Those combined features make distant beautiful sceneries nicely seen in motion pictures.

## **Upside Down Mode**

ZR30 gimbal automatically activates upside down mode when it is placed upside down, very convenient to be mounted on multiple kinds of vehicles like UGV, USV, robot dog, and robotics.

## **Gimbal Motion Mode**

Follow | Lock | FPV

### **Follow Mode**

Horizontally, gimbal follows when aircraft rotates.

### **Lock Mode**

Horizontally, gimbal does not follow when aircraft rotates.

### **FPV Mode**

Gimbal rotates simultaneously as aircraft rolls to get FPV view, and output enhanced stable images.

## **Starlight Night Vision Camera**

ZR30 comes with an ultra-sensitive starlight CMOS can keep image bright even in low light environment. HDR feature can precisely capture details of highlights and shadows in dynamic scenes, getting away of low light or backlight.

## **3-Axis Gimbal Stabilizing Control Algorithms**

### **High-Precision FOC Motor Control**

ZR30 gimbal camera is applied with industry-level 3-axis stabilizing technology and high-precision FOC control algorithms, which reduces most image shaking and ensure image is always stable even if aircraft or vehicle is vigorously moving. Meanwhile, camera continuously outputs smooth and clear images even in zooming. ZR30's yaw axis supports up to 540-degree rotation, which provides much freer observation angle during flight especially on VTOL drones and planes.

## 1.2 Parts

### 1.2.1 At a Glance



Interface of SIYI Quick Release Board



ZR30 Interface - Front



ZR30 Interface - Back

## 1.2.2 Pinouts

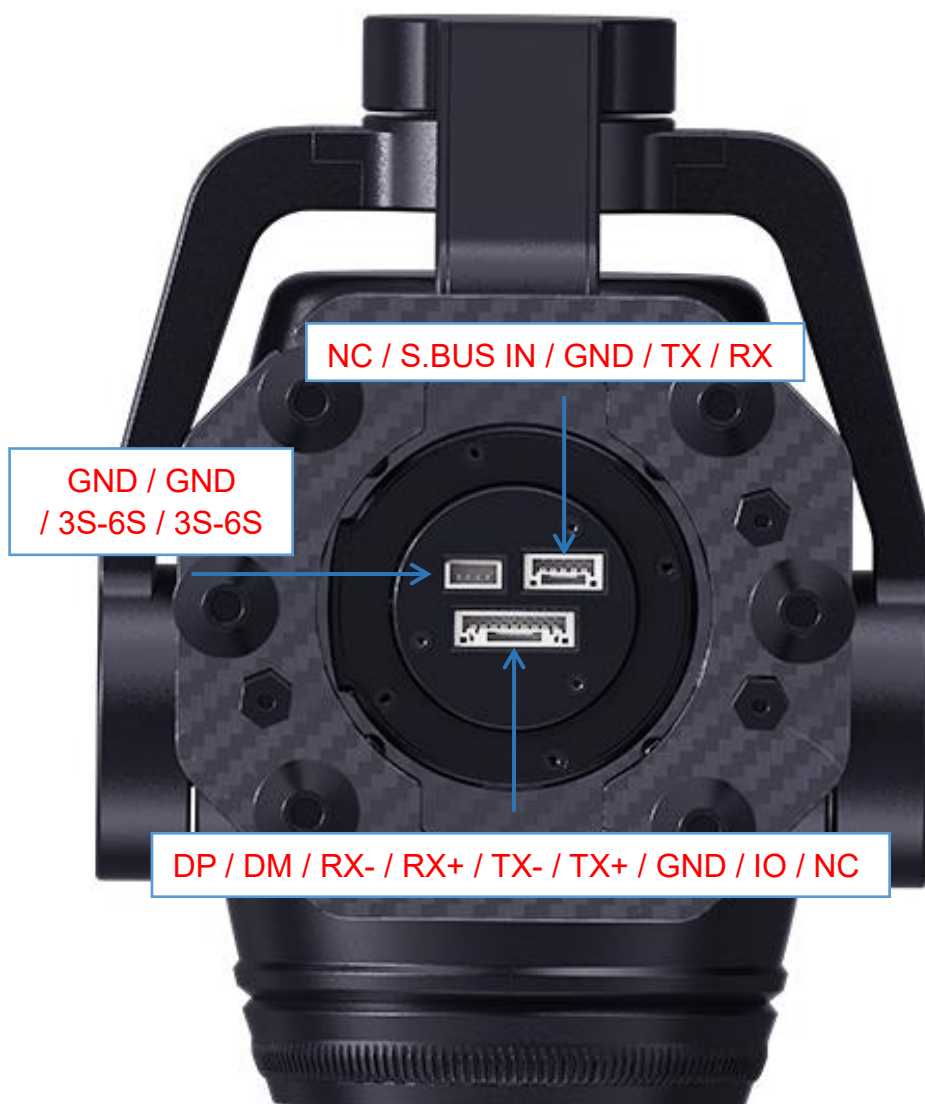

## 1.3 Technical Specification

### Overall

<b>Video Output Port</b>	Ethernet
<b>Control Signal Input Port</b>	S.Bus, UART UDP (Ethernet)
<b>Working Voltage</b>	11 ~ 25.2 V
<b>Power Consumption</b>	Summit 20W
<b>Working Temperature</b>	-10 ~ 50 °C
<b>Dimension</b> (Quick Release Board Included)	132*100*159 mm
<b>Weight</b> (Quick Release Board Included)	628 g

### Gimbal

<b>Angular Vibration Range</b>	$\pm 0.01^\circ$
<b>Controllable Pitch Angle</b>	$-90^\circ \sim +25^\circ$
<b>Controllable Yaw Angle</b>	$-270^\circ \sim +270^\circ$
<b>Rotatable Roll Angle</b>	$-45^\circ \sim +45^\circ$

### Camera

<b>Lens</b>	30X Optical Zoom (180X Hybrid Zoom)
<b>Focal Length</b>	$4.5\pm 5\% \sim 148.4\pm 5\%$ mm
<b>Image Sensor</b>	1/2.7 Inch, 8 MP effective resolution
<b>Aperture</b>	$F1.3\pm 5\% \sim 2.8\pm 5\%$
<b>FOV</b>	Diagonal: $65.4^\circ$ Horizontal: $58.1^\circ$

<b>TF Card Recording Resolution</b>	4K (4096 x 2160) @ 25 fps 2K (2560 x 1440) @ 30 fps 1080p (1920 x 1080) @ 30 fps 720p (1280 x 720) @ 30 fps
<b>Video Storage Bitrate</b>	12 Mbps (H.265 Codec)
<b>Supported File System</b>	FAT32
<b>Photography File Format</b>	JPG
<b>Video File Format</b>	MP4
<b>Supported TF Card Type</b>	MicroSD Class10, max 128 GB
<b>Still Photography Mode</b>	Single
<b>Metering Mode</b>	Evaluative metering
<b>White Balance</b>	Automatic

 **Mark**

To make sure that you get smoothly recorded video, please format the SD card and make the minimum storage unit as 64 KB before recording.



## 1.4 Packing List

1 x ZR30 Optical Pod

1 x ZR30 Quick Release Board

1 x MK15 / HM30 Air Unit S.Bus Y Cable

(Connect SIYI MK15 and HM30 air unit's S.Bus port to acquire control signal, then one connector of the cable goes to SIYI gimbal, another goes to flight controller)

1 x 3 in 1 Control Cable

(A universal cable for ZR30 and A8 mini, it connects SIYI gimbal's control signal port with SIYI link and controller, including UART control input, S.Bus input and output)

1 x SIYI Gimbal Power Cable

(Power supply cable for SIYI gimbal)

1 x SIYI Gimbal Ethernet Cable

(A backup cable for customer DIY purpose to connect SIYI gimbal to third-party Ethernet devices)

1 x SIYI Gimbal to SIYI Link Cable

(An all-in-one cable for only touch screen control to SIYI gimbal through SIYI link, it can power SIYI gimbal and can also transfer video stream and control signal)

1 x SIYI Gimbal Ethernet to RJ45 Cable

(Connect SIYI gimbal with RJ45 device directly)

1 x SIYI Gimbal Screw Pack

(Using with the fixing board to mount ZR30 gimbal, including 6 x Hex Socket Cap Screw M2.5\*5, 10 x Cross Recessed Flat Head Screw M2.5\*10, 8 x M2.5 Nut Black)

1 x ZR30 Mounting Board & Damper Pack

(For mounting and fixing gimbal and stabilization)

## 1.5 Indicator Definition

The status indicator on SIYI gimbal uses three different colors and different blinking frequencies to indicate the system's working or abnormal status.

- Solid Green: Normally working.
- Slow Green Blinks: S.Bus signal input is normal.
- Slow Red Blinks: One of or all of the firmware does not match (camera firmware, gimbal firmware, zoom firmware).
- ● ● Triple Red Blinks: Failed to identify zoom module.
- ● ● Red-Red-Yellow Blinks Continuously: Failed to identify camera board.
- Yellow Blinks: Power input voltage is low (lower than 10 V).
- ● Double Red Blinks: IMU temperature rising is abnormal.
- ● Double Yellow Blinks: IMU temperature is rising.
- ● ● Triple Yellow Blinks: IMU temperature is abnormal.

## 2 GET READY TO USE ZR30

### 2.1 Installation

#### Screw Holes' Position and Distance

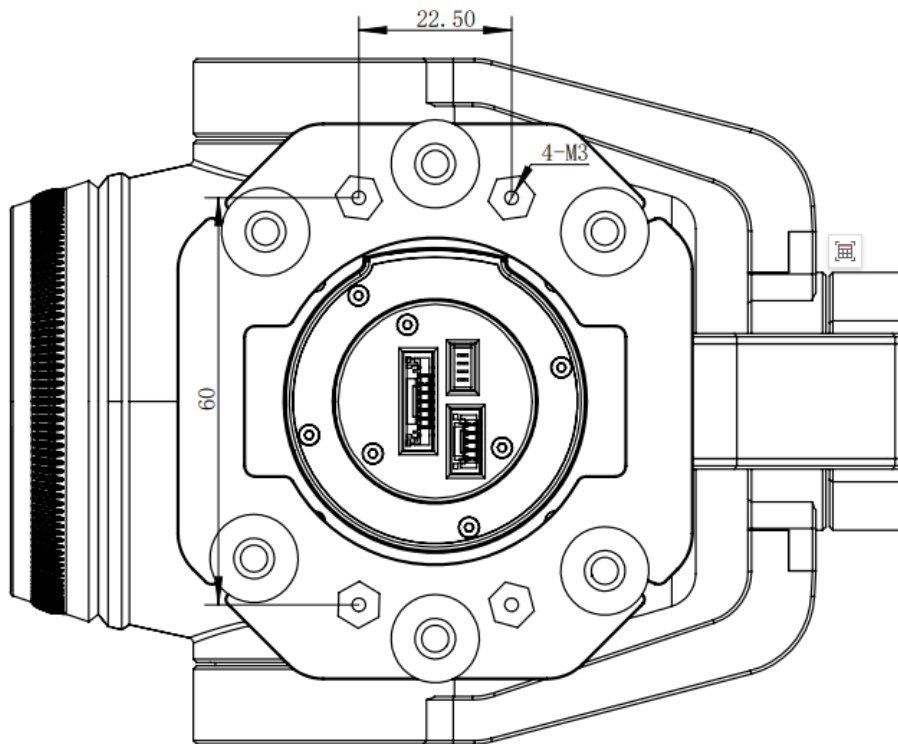

#### Mark

The specs of the screws for fixing the four tube screws are M.25\*8 mm. Quantity: 4.

Welcome to contact SIYI to get the 3D file of SIYI gimbal for pre-installation.

## 2.2 Connection and Power

SIYI optical pod and gimbal camera can be powered in many ways. If you plan to carry SIYI gimbal by your plane and the plane may roll in a wide margin, then please use connect SIYI gimbal's power port directly by a 3S to 6S power battery, not through power distribution board or air unit.

## 3 GIMBAL CONTROL

SIYI optical pod and gimbal camera support multiple methods to control.

### 3.1 Control Gimbal Camera from SIYI FPV App or SIYI QGC on SIYI Handheld Ground Station

Gimbal can connect to air unit directly, then you can control gimbal rotation, gimbal functions, and display video in SIYI FPV app or SIYI QGC app on screen after binding it with the air unit.

#### 3.1.1 Preparation

It is necessary to prepare the tools, firmware, and software below before controlling gimbal camera in this way.

- SIYI Handheld Smart Controller (MK32 Standard Combo / MK15 Enterprise Standard Combo is suggested for using conveniently with SIYI Gimbal)
- ZR30 Optical Pod

#### **Mark**

Above products can be purchased from SIYI directly or from SIYI authorized dealers.

- SIYI Gimbal to SIYI Link Cable

## **Mark**

Above tools come with product package.

- SIYI FPV App (v2.5.10.514 or latest version)
- SIYI QGC App

## **Mark**

Above software can be downloaded from relevant product page on SIYI official website.

### **SIYI FPV App Steps**

1. Power air unit and bind it with ground station.
2. Use SIYI Gimbal to SIYI Link Cable to connect the air unit's Ethernet port with the gimbal quick release board's Ethernet port.
3. Update SIYI FPV app to the latest.
4. Run SIYI FPV app, go to "Settings – ZR30", and select "SIYI Camera 1" (when IP addresses are 192.168.144.25) or "SIYI Camera 2" (when IP addresses are 192.168.144.26), video stream will display. Gimbal motion and camera functions can be controlled by ground station touchscreen.

### **SIYI QGC App Steps**

1. Power air unit and bind it with ground station.
2. Use SIYI Gimbal to SIYI Link Cable to connect the air unit's Ethernet port with the gimbal quick release board's Ethernet port.
3. Run SIYI QGC app, go to "Comm Links – Video Settings", and select "RTSP Video Stream" for "Source", then enter the default RTSP addresses of SIYI gimbal camera (rtsp://192.168.144.25:8554/main.264), video stream will display. Gimbal motion and camera functions can be controlled by ground station touchscreen.

### 3.1.2 Gimbal Pitch and Yaw Rotation

While SIYI FPV App or SIYI QGC app is running,

Sliding on touchscreen can control gimbal rotation. Sliding left and right are yaw rotation, up and down are gimbal pitch rotation.

Double tap touchscreen, gimbal will automatically center.

#### **Mark**

Slide on touchscreen and hold it, gimbal will continue rotating till it reaches physical limit.

Farther that you hold it from the center of the screen, faster the gimbal rotates.

### 3.1.3 Zoom and Focus

While SIYI FPV App or SIYI QGC app is running,

Touching “Zoom in” or “Zoom out” icon on can control camera image zooming, up to 180X hybrid zoom. Optical zoom from 1X to 30X, digital zoom from 30X to 180X.

Touching “Close Shot” or “Long Shot” icon, focal length will change from 5 to 150 mm.

Tap touchscreen, camera will focus automatically.

### 3.1.4 Take pictures and Record Video

While SIYI FPV App or SIYI QGC app is running,

Touch “Photo” icon once on to take a picture. Touch “Record” icon to start video recording. Touch “Recording” icon to stop video recording.

#### **Mark**

Before taking a picture or recording video, it is necessary to insert TF/SD card into the camera.

## 3.2 Control Gimbal through S.Bus Signal (Taking an Example of MK15)

Gimbal can be connected to MK15 air unit for gimbal and camera control through joysticks, dials, switches, and buttons on MK15 remote controller after binding.



### 3.2.1 Preparation

It is necessary to prepare the below tools, firmware, and software before controlling gimbal camera in this way.

- MK15 Mini Handheld Smart Controller (Enterprise standard combo is suggested for conveniently using with SIYI gimbal)
- ZR30 Optical Pod

#### **Mark**

Above products can be purchased from SIYI directly or from SIYI authorized dealers.

- SIYI Gimbal to SIYI Link Cable
- 3 in 1 Control Cable (For ZR30 and A8 mini)
- MK15 / HM30 Air Unit S.Bus Y Cable

#### **Mark**

Above tools come with product package.

- Cable (USB-C to USB-A)

#### **Mark**

Above tools should be prepared by customer.

- SIYI PC Assistant (v1.3.2 or latest version)

## **Mark**

Above software can be downloaded from relevant product page on SIYI official website.

## **Steps**

1. Power MK15 air unit and bind it with MK15 remote controller.
2. Use SIYI Gimbal to SIYI Link Cable to connect MK15 air unit's Ethernet port with gimbal quick release board's Ethernet port.
3. Wire the 3 in 1 Control Cable with the MK15 / HM30 Air Unit S.Bus Y Cable.
4. Then use the combined cable to connect MK15 air unit's RC port and gimbal quick release board's control signal port.
5. Install and run SIYI PC Assistant on Windows computer.
6. Use the USB-C to USB-A cable to connect the gimbal to the computer, then run SIYI PC Assistant and go to "Gimbal Config" page.

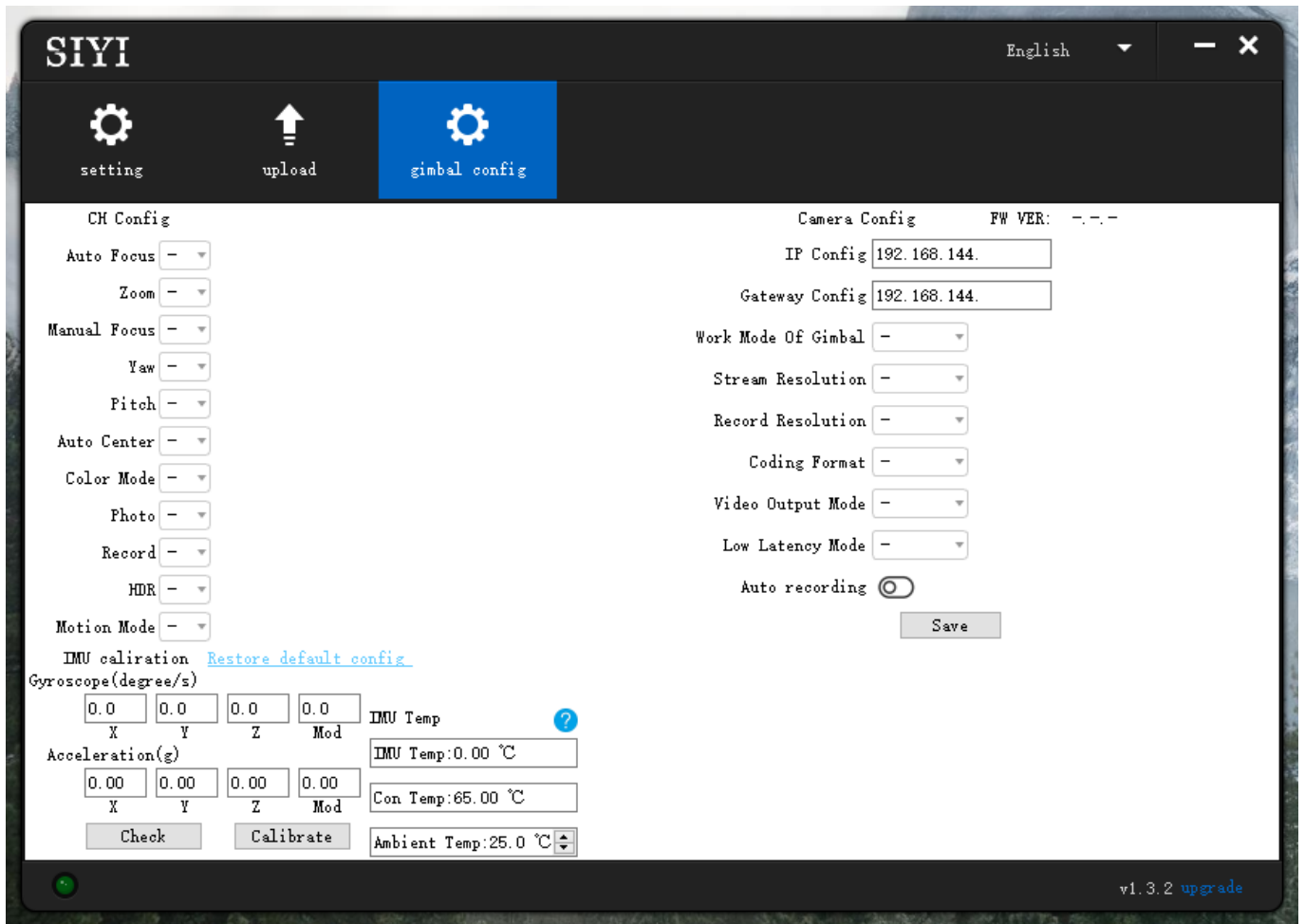

7. Under “Channel Config” page, assign remote controller channel 1 to 16 to target gimbal / camera functions according to your requirement.
8. For the assigned channels, operate their mapped joysticks, dials, switches, and buttons on MK15 remote controller to confirm if they are working normally.

### 3.2.2 Gimbal Pitch and Yaw Rotation (Taking an Example of MK15 Dials)

Below are the MK15 channel mapping settings for gimbal testing, customers are free to assign MK15 channel mappings as required through SIYI TX app.

- Channel 7 = Left Dial (Reversed)

- Channel 8 = Right Dial
- Channel 12 = Button D

In SIYI PC Assistant, map “Yaw” function to channel 7 and “Pitch” to channel 8, “Center” to channel 12.

Then, if you operate the left dial on MK15 remote controller, gimbal will rotate around yaw axis. If you operate the right dial, gimbal will rotate around pitch axis. Press button D, gimbal will center automatically.

### Mark

Hold the dial from its center position, gimbal will rotate till reaching limit. Farther that you hold it away from center screen, faster gimbal rotates.

### 3.2.3 Zoom and Focus (Taking an Example of MK15 Switches)

Below are the MK15 channel mapping settings for gimbal testing, customers are free to assign MK15 channel mappings as required through SIYI TX app.

- Channel 13 = Left Switch SA
- Channel 14 = Left Switch SB
- Channel 11 = Button C

In SIYI PC Assistant, map “Zoom” function to channel 13 and “Focus” to channel

14, “Auto Focus” to channel 11.

Then, if you operate the SA switch on MK15 remote controller, camera will zoom in or zoom out, optical zoom from 1X to 10X, digital zoom from 10X to 30X. If you operate the SB switch, camera will focus from 5 mm to 47 mm.

Press button C and camera will focus automatically.

### 3.2.4 Take Pictures and Record Video (Taking an Example of MK15 Buttons)

Below are the MK15 channel mapping settings for gimbal testing, customers are free to assign MK15 channel mappings as required through SIYI TX app.

- Channel 9 = Button A
- Channel 10 = Button B

In SIYI PC Assistant, map “Photo” function to channel 9 and “Record” to channel 10.

Then, if you press button A on MK15 remote controller, camera will take a picture.

If you press button B, camera will start or stop video recording.

#### **Mark**

Before taking pictures or recording video, it is necessary to insert SD / TF card into the camera.

### 3.3 UART / UDP Control (through SDK)

SIYI gimbal provides control and function protocol for all customers, please refer to the below file “SIYI Gimbal Camera SDK Communication Protocol” for secondary development.

#### 3.3.1 SDK Protocol Format

Field	Index	Bytes	Description
STX	0	2	0x6655: starting mark <b>Low byte in the front</b>
CTRL	2	1	0: need_ack (if the current data pack need “ack”) 1: ack_pack (if the current data pack is an “ack” package) 2-7: reserved
Data_len	3	2	Date field byte length <b>Low byte in the front</b>
SEQ	5	2	Frame sequence (0 ~ 65535) <b>Low byte in the front</b>
CMD_ID	7	1	Command ID
DATA	8	Data_len	Data
CRC16		2	CRC16 check to the complete data package. <b>Low byte in the front</b>

#### 3.3.2 SDK Communication Commands

##### Acquire Firmware Version

CMD_ID:0x01-----Acquire Firmware Version			
Send data format			
No.	Data Type	Data Name	Description
ACK data format			
	uint32_t	code_board_ver	Camera firmware version

uint32_t	gimbal_firmware_ver	Gimbal firmware version
uint32_t	zoom_firmware_ver	Zoom firmware version

Eg: 0x6E030203 --> firmware version v3.2.3

Mark:

1. Ignore the 4<sup>th</sup> byte (higher byte)
2. Zoom firmware version is only available for ZR10 and ZR30 at this moment.

## Acquire Hardware ID

CMD_ID:0x02----- Hardware ID			
Send data format			
No.	Data Type	Data Name	Description
ACK data format			
	Uint8_t	hardware_id[12]	Hardware ID character string (10 digits)

## Auto Focus

CMD_ID:0x04-----Auto Focus			
Send data format			
No.	Data Type	Data Name	Description
1	uint8_t	auto_focus	1: Start auto focus for once
ACK data format			
1	uint8_t	sta	1: Success 0: Fail

## Manual Zoom and Auto Focus

CMD_ID:0x05-----Manual Zoom and Auto Focus			
Send data format			
No.	Data Type	Data Name	Data Description
1	int8_t	zoom	1: Start zooming in 0: Stop zooming in / out (send when released from control command) -1: Start zooming out
ACK data format			
	uint16_t	zoom_multiple	Current (hybrid) zoom multiples, (zoom_multiple / 10, accurate to one

			decimal point)
--	--	--	----------------

## Absolute Zoom and Auto Focus

CMD_ID:0x0F-----Absolute Zoom and Auto Focus			
Send data format			
No.	Data Type	Data Name	Data Description
1	uint8_t	Absolute_movemen t_int	Input the integer part of the target multiple (0X1 ~ 0X1E)
2	uint8_t	Absolute_movemen t_float	Input the fractional part of the target multiple (0X0 ~ 0X9)
ACK data format			
	uint8_t	Absolute_movemen t_ask	Success and return to 1

Mark:

Only available on ZR10 at this moment.

## Manual Focus

CMD_ID:0x06-----Manual Focus			
Send data format			
No.	Data Type	Data Name	Description
1	int8_t	focus	1: Long shot 0: Stop manual focus (send when released from control command) -1: Close shot
ACK data format			
	uint8_t	sta	1: Success 0: Fail

Mark:

Only available on ZR10 at this moment.

## Gimbal Rotation

CMD_ID:0x07-----Gimbal Rotation			
Send data format			
No.	Date Type	Date Name	Description
1	int8_t	turn_yaw	-100~0~100: Negative and positive represent two directions, higher



			or lower the number is away from 0, faster the rotation speed is. Send 0 when released from control command and gimbal stops rotation.
2	int8_t	turn_pitch	-100~0~100: Same as above
ACK data format			
	uint8_t	sta	1: Success 0: Fail

## Center

CMD_ID:0x08-----Center			
Send data format			
No.	Data Type	Data Name	Description
1	uint8_t	center_pos	1: gimbal centers to position 0
ACK data format			
1	uint8_t	sta	1: Success 0: Fail

## Acquire Gimbal Configuration Information

CMD_ID:0x0A-----Acquire Gimbal Configuration Information			
Send data format			
No.	Data Type	Data Name	Description
ACK data format			
1	uint8_t	reserved	
2	uint8_t	hdr_sta	0: HDR OFF 1: HDR ON
3	uint8_t	reserved	
4	uint8_t	record_sta	0: Recording OFF 1: Recording ON 2: TF card slot is empty 3: (Recording) Data loss in TF card recorded video, please check TF card
5	uint8_t	gimbal_motion_mode	0: Lock Mode 1: Follow Mode 2: FPV Mode
6	uint8_t	gimbal_mounting_dir	Gimbal Mounting Method 0: Reserved

			1: Normal 2: Upside Down
7	uint8_t	video_hdmi_or_cvbs	(Only available on A8 mini) Video output status of HDMI and CVBS: 0: HDMI output ON CVBS output OFF 1: HDMI output OFF CVBS output ON

## Function Feedback Information

CMD_ID:0x0B-----Function Feedback Information			
Send data format			
No.	Data Type	Data Name	Description
ACK data format			
1	uint8_t	info_type	0: Success 1: Fail to take a photo (Please check if TF card is inserted) 2: HDR ON 3: HDR OFF 4: Fail to record a video (Please check if TF card is inserted)

## Photo and Video

CMD_ID:0x0C-----Photo			
Send data format			
No.	Data Type	Data Name	Description
	uint8_t	func_type	0: Take a picture 1: Switch on / off HDR (not supported yet) 2: Start / Stop Recording 3: Motion – Lock Mode 4: Motion – Follow Mode 5: Motion – FPV Mode 6: Set video output as HDMI (Only available on A8 mini, restart gimbal to take effect) 7: Set video output as CVBS

			(Only available on A8 mini, restart gimbal to take effect) 8: Turn off both HDMI and CVBS video output (Only available on A8 mini, restart gimbal to take effect)
ACK data format			
			No ack

## Acquire Gimbal Attitude

CMD_ID:0x0D-----Acquire Gimbal Attitude			
Send data format			
No.	Data Type	Data Name	Description
ACK data format			
	int16_t	yaw	Yaw axis degree
	int16_t	pitch	Pitch axis degree
	int16_t	roll	Roll axis degree
	int16_t	yaw_velocity	Yaw axis rotation speed
	int16_t	pitch_velocity	Pitch axis rotation speed
	int16_t	roll_velocity	Roll axis rotation speed

Mark:

The above data to be divided by 10 is the actual degree, accuracy in one decimal place.

## Set Gimbal Control Angle

CMD_ID:0x0E-----Set Gimbal Control Angle			
Send data format			
No.	Data Type	Data Name	Description
	int16_t	yaw	Target yaw angle
	int16_t	pitch	Target pitch angle
ACK data format			
	int16_t	yaw	Current yaw angle
	int16_t	pitch	Current pitch angle
	int16_t	roll	Current roll angle

### Angle Control Range

Yaw:

- A8 mini: -135.0 ~ 135.0 degree
- ZR10 / ZR30: Same with A8 mini

Pitch

- A8 mini: -90.0 ~ 25.0 degree
- ZR10 / ZR30: Same with A8 mini

**Mark:**

The accuracy of the control angle is in one decimal place. Eg: Set yaw as 60.5 degrees, the command number should be set as 605.

The actual angle data returned to be divided by 10 is the actual degree, accuracy in one decimal place.

### 3.3.3 ZR10 SDK Communication Interface

#### TTL Serial Port

- Baud rate: 115200
- Data position: 8 digits. Stop position: 1 digit. No check.

#### UDP

- IP: 192.168.144.25
- Port Number: 37260

### 3.3.4 ZR10 SDK Communication Code Examples

Zoom 1

55 66 01 01 00 00 00 05 01 8d 64

Zoom -1

55 66 01 01 00 00 00 05 FF 5c 6a

Absolute Zoom (4.5X)

55 66 01 02 00 01 00 0F 04 05 60 BB

Manual Focus 1

55 66 01 01 00 00 00 06 01 de 31

Manual Focus -1

55 66 01 01 00 00 00 06 ff 0f 3f

Take Pictures

55 66 01 01 00 00 00 0c 00 34 ce

Record Video

55 66 01 01 00 00 00 0c 02 76 ee

Rotate 100 100

55 66 01 02 00 00 00 07 64 64 3d cf

Auto Centering

55 66 01 01 00 00 00 08 01 d1 12

Gimbal Status Information

55 66 01 00 00 00 00 0a 0f 75

Auto Focus

55 66 01 01 00 00 00 04 01 bc 57

Acquire Hardware ID

55 66 01 00 00 00 00 02 07 f4

Acquire Firmware Version

55 66 01 00 00 00 00 01 64 c4

Lock Mode

55 66 01 01 00 00 00 0c 03 57 fe

Follow Mode

55 66 01 01 00 00 00 0c 04 b0 8e

FPV Mode

55 66 01 01 00 00 00 0c 05 91 9e

Acquire Attitude Data

55 66 01 00 00 00 00 0d e8 05

Set Video Output as HDMI (Only available on A8 mini, restart to take effect)

55 66 01 01 00 00 00 0c 06 f2 ae

Set Video Output as CVBS (Only available on A8 mini, restart to take effect)

55 66 01 01 00 00 00 0c 07 d3 be

Turn Off both CVBS and HDMI Output (Only available on A8 mini, restart to take effect)

55 66 01 01 00 00 00 0c 08 3c 4f

### 3.3.5 SDK CRC16 Code

```

const uint16_t crc16_tab[256];
/*****
CRC16 Coding & Decoding G(X) = X^16+X^12+X^5+1
*****/
uint16_t CRC16_cal(uint8_t *ptr, uint32_t len, uint16_t crc_init)
{
    uint16_t crc,   oldcrc16;
    uint8_t  temp;
    crc = crc_init;
    while (len--!=0)
    {
        temp=(crc>>8)&0xff;
        oldcrc16=crc16_tab[*ptr^temp];
        crc=(crc<<8)^oldcrc16;
        ptr++;
    }
    //crc=~crc;    //??
    return(crc);
}

uint8_t crc_check_16bites(uint8_t* pbuf, uint32_t len, uint32_t* p_result)
{
    uint16_t crc_result = 0;
    crc_result= CRC16_cal(pbuf,len, 0);
    *p_result = crc_result;

    return 2;
}

const uint16_t crc16_tab[256]= {0x0,0x1021,0x2042,0x3063,0x4084,0x50a5,0x60c6,0x70e7,
                                0x8108,0x9129,0xa14a,0xb16b,0xc18c,0xd1ad,0xe1ce,0xf1ef,
                                0x1231,0x2210,0x3273,0x2252,0x52b5,0x4294,0x72f7,0x62d6,
                                0x9339,0x8318,0xb37b,0xa35a,0xd3bd,0xc39c,0xf3ff,0xe3de,
                                0x2462,0x3443,0x4420,0x1401,0x64e6,0x74c7,0x44a4,0x5485,
                                0xa56a,0xb54b,0x8528,0x9509,0xe5ee,0xf5cf,0xc5ac,0xd58d,
                                0x3653,0x2672,0x1611,0x6630,0x76d7,0x66f6,0x5695,0x46b4,
                                0xb75b,0xa77a,0x9719,0x8738,0xf7df,0xe7fe,0xd79d,0xc7bc,

```

0x48c4,0x58e5,0x6886,0x78a7,0x840,0x1861,0x2802,0x3823,  
0xc9cc,0xd9ed,0xe98e,0xf9af,0x8948,0x9969,0xa90a,0xb92b,  
0x5af5,0x4ad4,0x7ab7,0x6a96,0x1a71,0xa50,0x3a33,0x2a12,  
0xdbfd,0xcbdc,0xfbbf,0xeb9e,0x9b79,0x8b58,0xbb3b,0xab1a,  
0x6ca6,0x7c87,0x4ce4,0x5cc5,0x2c22,0x3c03,0xc60,0x1c41,  
0xedae,0xfd8f,0xcdec,0xddcd,0xad2a,0xbd0b,0x8d68,0x9d49,  
0x7e97,0x6eb6,0x5ed5,0x4ef4,0x3e13,0x2e32,0x1e51,0xe70,  
0xff9f,0xefbe,0xdfdd,0xcffc,0xbf1b,0xaf3a,0x9f59,0x8f78,  
0x9188,0x81a9,0xb1ca,0xa1eb,0xd10c,0xc12d,0xf14e,0xe16f,  
0x1080,0xa1,0x30c2,0x20e3,0x5004,0x4025,0x7046,0x6067,  
0x83b9,0x9398,0xa3fb,0xb3da,0xc33d,0xd31c,0xe37f,0xf35e,  
0x2b1,0x1290,0x22f3,0x32d2,0x4235,0x5214,0x6277,0x7256,  
0xb5ea,0xa5cb,0x95a8,0x8589,0xf56e,0xe54f,0xd52c,0xc50d,  
0x34e2,0x24c3,0x14a0,0x481,0x7466,0x6447,0x5424,0x4405,  
0xa7db,0xb7fa,0x8799,0x97b8,0xe75f,0xf77e,0xc71d,0xd73c,  
0x26d3,0x36f2,0x691,0x16b0,0x6657,0x7676,0x4615,0x5634,  
0xd94c,0xc96d,0xf90e,0xe92f,0x99c8,0x89e9,0xb98a,0xa9ab,  
0x5844,0x4865,0x7806,0x6827,0x18c0,0x8e1,0x3882,0x28a3,  
0xcb7d,0xdb5c,0xeb3f,0xfb1e,0x8bf9,0x9bd8,0xabbb,0xbb9a,  
0x4a75,0x5a54,0x6a37,0x7a16,0xaf1,0x1ad0,0x2ab3,0x3a92,  
0xfd2e,0xed0f,0xdd6c,0xcd4d,0xbdaa,0xad8b,0x9de8,0x8dc9,  
0x7c26,0x6c07,0x5c64,0x4c45,0x3ca2,0x2c83,0x1ce0,0xcc1,  
0xef1f,0xff3e,0xcf5d,0xdf7c,0xaf9b,0xbfba,0x8fd9,0x9ff8,  
0x6e17,0x7e36,0x4e55,0x5e74,0x2e93,0x3eb2,0xed1,0x1ef0

};

## 4 VIDEO OUTPUT

ZR30 optical pod supports both Ethernet and HDMI port for outputting video stream.

### **Mark**

ZR30's Ethernet port and HDMI port can output video stream simultaneously.

### **4.1 Output and Display Video on SIYI Handheld Ground Station**

Gimbal can connect to air unit directly, then video will be displayed in SIYI FPV app or in SIYI QGC app after binding the air unit to the ground station.

Please refer to Chapter 3.1 in this manual for more detail.

### **4.2 Output Video Stream through HM30 Full HD Image Transmission System**

Gimbal camera can connect to HM30 air unit directly, then video will be displayed in SIYI FPV app or SIYI QGC app or other methods that HM30 supports after binding the air unit to the ground unit.

#### **Preparation**

It is necessary to prepare the tools, firmware, and software below before outputting video stream in this way.



- HM30 Full HD Image Transmission System
- ZR30 Optical Pod

 **Mark**

Above products can be purchased from SIYI directly or from SIYI authorized dealers.

- SIYI Gimbal to Link Cable

 **Mark**

Above tools come with product package.

- SIYI FPV App (v2.5.10.514 or latest version)
- SIYI QGC App

 **Mark**

Above software can be downloaded from relevant product page on SIYI official website.

### **SIYI FPV App Steps**

1. Power air unit and bind it with ground station.
2. Use SIYI Gimbal to SIYI Link Cable to connect the air unit's Ethernet port with the gimbal quick release board's Ethernet port.

3. Update SIYI FPV app to the latest.
4. Run SIYI FPV app, go to “Settings – ZR30”, and select “SIYI Camera 1” (when IP addresses are 192.168.144.25) or “SIYI Camera 2” (when IP addresses are 192.168.144.26), video stream will display. Gimbal motion and camera functions can be controlled by ground station touchscreen.

### **SIYI QGC App Steps**

1. Power air unit and bind it with ground station.
2. Use SIYI Gimbal to SIYI Link Cable to connect the air unit’s Ethernet port with the gimbal quick release board’s Ethernet port.
3. Run SIYI QGC app, go to “Comm Links – Video Settings”, and select “RTSP Video Stream” for “Source”, then enter the default RTSP addresses of SIYI gimbal camera (rtsp://192.168.144.25:8554/main.264), video stream will display. Gimbal motion and camera functions can be controlled by ground station touchscreen.

## **4.3 Output Video to Third-Party Link**

SIYI gimbal can output video stream to any third-party link which provides Ethernet port and is compatible with RTSP video stream.

In this way, it is necessary to prepare a customized video cable for connection between SIYI gimbal camera and the third-party link.



## CAUTION

SIYI gimbal Ethernet port's "RX-" pinout should connect to the third-party link Ethernet port's "RX-" pinout, and "RX+" pinout to "RX+" pinout. Do not cross the pinouts, otherwise it will cause damage to the device.

### Steps

1. Power the air unit of the third-party link and bind it with the ground unit.
2. Use the video cable to connect SIYI gimbal's Ethernet port and the third-party link's Ethernet port.
3. Open RTSP video player and input SIYI gimbal camera's RTSP addresses (rtsp://192.168.144.25:8554/main.264), if video displays normally, connection is successful.

## 4.4 Output by HDMI

ZR30 can output video to any HDMI monitor or to third-party link which support HDMI input through the Micro-HDMI port.



### Mark

The default video output mode of ZR30 is Ethernet.

Go to the "Gimbal Config" page in SIYI Assistant program to change the video output mode to HDMI, then ZR30 video will stream from its Micro-HDMI port on the quick release

board.

When ZR30 is outputting video to third-party link through HDMI, SIYI FPV and SIYI FPV app cannot control the gimbal by touchscreen. Please use S.Bus or UART control instead.

## 4.5 Solutions to No Image

If SIYI gimbal failed to output video or the video cannot be displayed properly, please follow the steps below to investigate possible reasons.

1. Confirm if the link's ground unit is bound with the air unit and if the camera is connected to the air unit.
2. Check Camera IP addresses and RTSP addresses.

If video still does not show up, please follow the steps below and make a deep investigation according to the video output mode and the video display device you use.

### 4.5.1 Video Output to Android Device

1. Input SIYI gimbal's default IP addresses "192.168.144.25" in the "Ping Tools" app and check if the network communication is successful. If there is a response, then check if the RTSP address in the video player is correct.



### Successful Network Communication

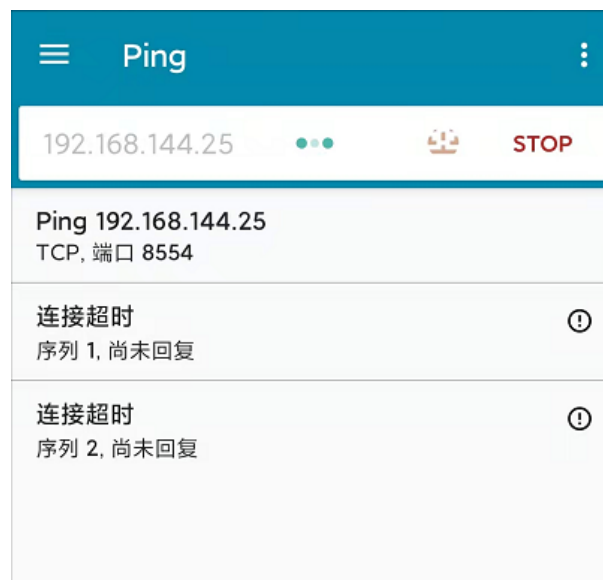

### Network Communication Failed

2. If the network communication is failed, then please check if the communication between the image transmission system's ground unit and the air unit is successful. If it is, then please check if the video cable between camera and image transmission system's air unit is good, and if the voltage input is in normal range.

## 4.5.2 Video Output to Windows Device

1. Use the “Win + R” key combo to wake up the “Run” program and input the command “cmd”.

```

C:\Windows\system32\cmd.exe
Microsoft Windows [版本 10.0.19042.804]
(c) 2020 Microsoft Corporation. 保留所有权利。

C:\Users\Administrator>ping 192.168.144

正在 Ping 192.168.0.144 具有 32 字节的数据:
Control-C
^C
C:\Users\Administrator>ping 192.168.144.25

正在 Ping 192.168.144.25 具有 32 字节的数据:
来自 192.168.144.25 的回复: 字节=32 时间=9ms TTL=64
来自 192.168.144.25 的回复: 字节=32 时间=3ms TTL=64
来自 192.168.144.25 的回复: 字节=32 时间=4ms TTL=64
来自 192.168.144.25 的回复: 字节=32 时间=3ms TTL=64

```

Successful Network Communication

```

C:\Windows\system32\cmd.exe

正在 Ping 192.168.144.25 具有 32 字节的数据:
Control-C
^C
C:\Users\Administrator>ping 192.168.144.25

正在 Ping 192.168.144.25 具有 32 字节的数据:
请求超时。
请求超时。
来自 192.168.144.153 的回复: 无法访问目标主机。
来自 192.168.144.153 的回复: 无法访问目标主机。

192.168.144.25 的 Ping 统计信息:
    数据包: 已发送 = 4, 已接收 = 2, 丢失 = 2 (50% 丢失),
C:\Users\Administrator>

```

Network Communication Failed

2. Input the SIYI gimbal’s default IP addresses “192.168.144.25” and press the “Enter” key to check if communication is successful. If it is successful, please check if the RTSP addresses in the RTSP player is correct or try to switch to other video players.



3. If the network communication is failed, then please check if the communication between the image transmission system's ground unit and the air unit is successful. If it is, then please check if the video cable between camera and image transmission system's air unit is good, and if the voltage input is in normal range.

**Mark**

If you have done investigation by following all steps above, but the reason is still not located, please contact your dealer or contact SIYI Support immediately.

## 4.6 Common IP Addresses

SIYI Gimbal's Default IP Addresses: 192.168.144.25

SIYI Gimbal's Default RTSP Addresses: rtsp://192.168.144.25:8554/main.264

SIYI FPV App's "SIYI Camera 1" IP Addresses: 192.168.144.25

SIYI FPV App's "SIYI Camera 2" IP Addresses: 192.168.144.26

## 5 SIYI FPV APP

SIYI FPV is an Android application developed by SIYI to configure multiple SIYI devices for image transmission settings, camera settings, video stream display, and link status monitor.

### **Mark**

The manual is edited based on SIYI FPV App v2.5.10.514.

SIYI FPV App can be download from the relevant product pages on SIYI official store.

SIYI FPV App compatible SIYI devices.

- ZR30 4K AI 180X Hybrid Zoom Optical Pod
- A2 mini Ultra-Wide-Angle FPV Gimbal
- MK32 Enterprise Handheld Ground Station
- A8 mini AI Mini Zoom Gimbal Camera
- ZR10 2K QHD 30X Hybrid Zoom Gimbal Camera
- R1 / R1M HD Recording FPV Camera
- Air Unit HDMI Input Converter
- HM30 Full HD Image Transmission System
- MK15 / MK15E Mini HD Handheld Smart Controller



## SIYI FPV App OSD Information Definition

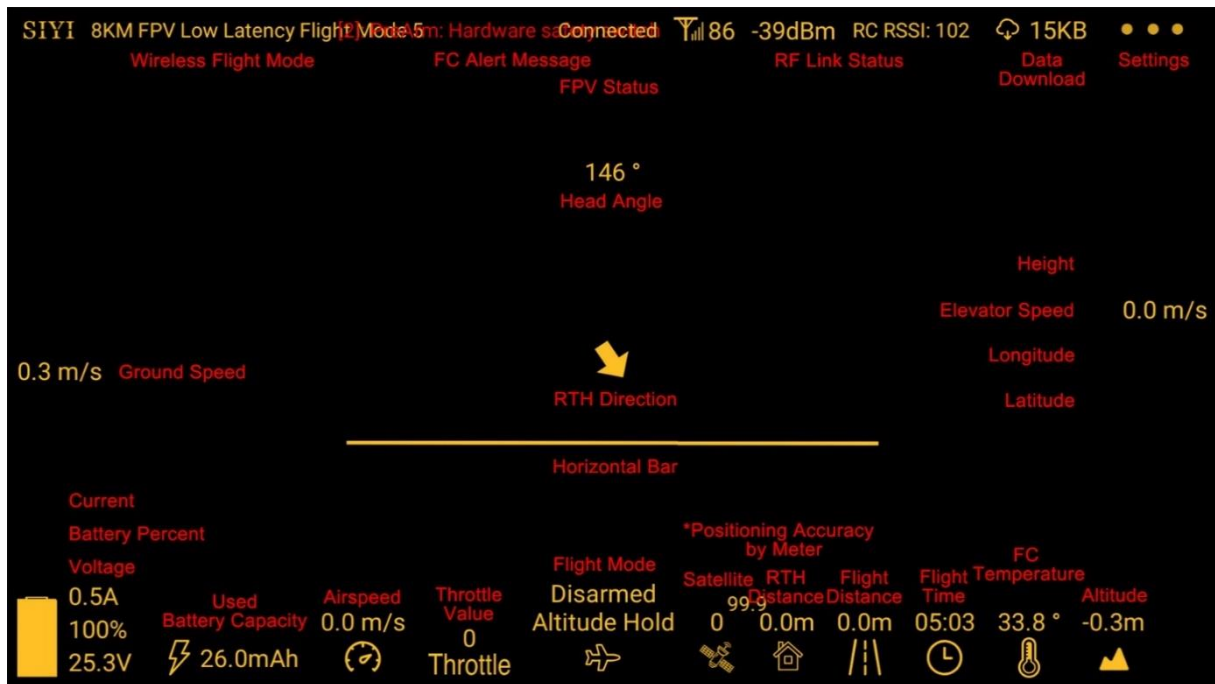

## SIYI FPV Camera Function Icon Definition



## 5.1 Settings

In the “Settings” page, you can configure camera IP Addresses, configure application interface, switch decoding type.

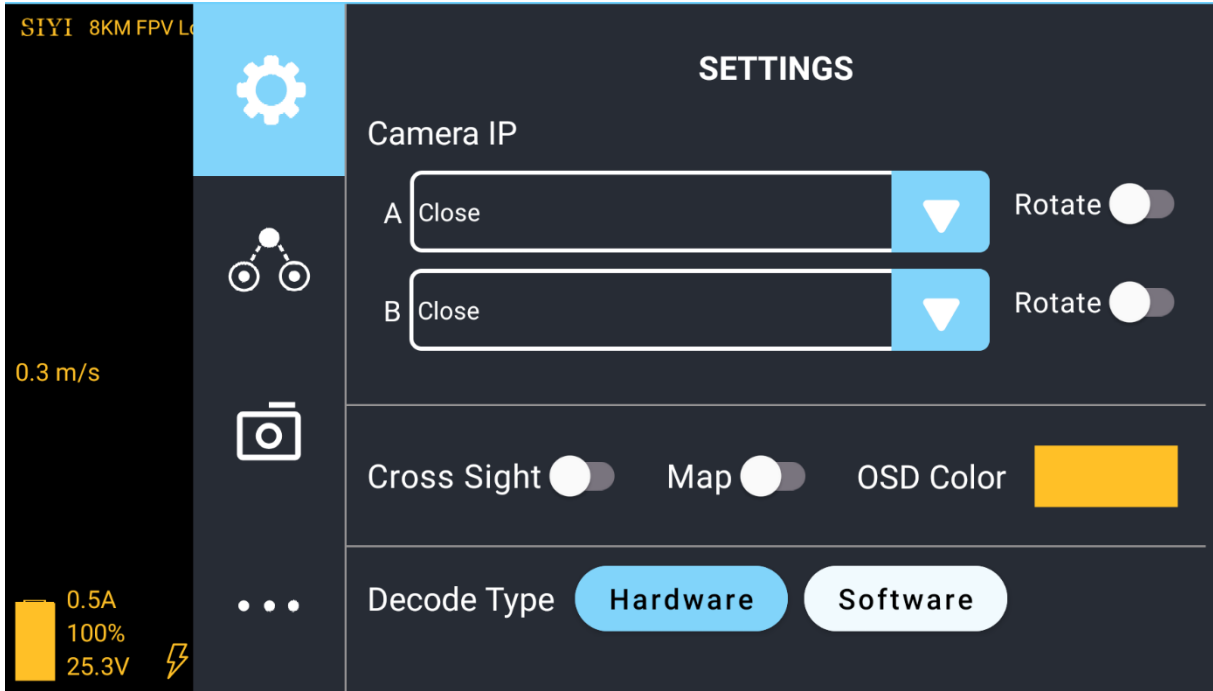

### About Settings

**Camera IP:** Select SIYI Camera 1 and SIYI Camera 2, or input camera RTSP addresses manually, or disable image. The “Rotate” buttons can rotate the image in 180 degrees.

**Cross Sight:** Display a cross sight in the center of the image.

**Map:** Display the flight map at the left-bottom corner of the app.

**OSD Color:** Adjust the color of all OSD information.

**Decoding Type:** Switch between “Hardware Decoding” and “Software Decoding”. Please refer to your video input device to choose the decoding type with the best performance.

## 5.2 Link Status

Display the link status directly over the FPV image.

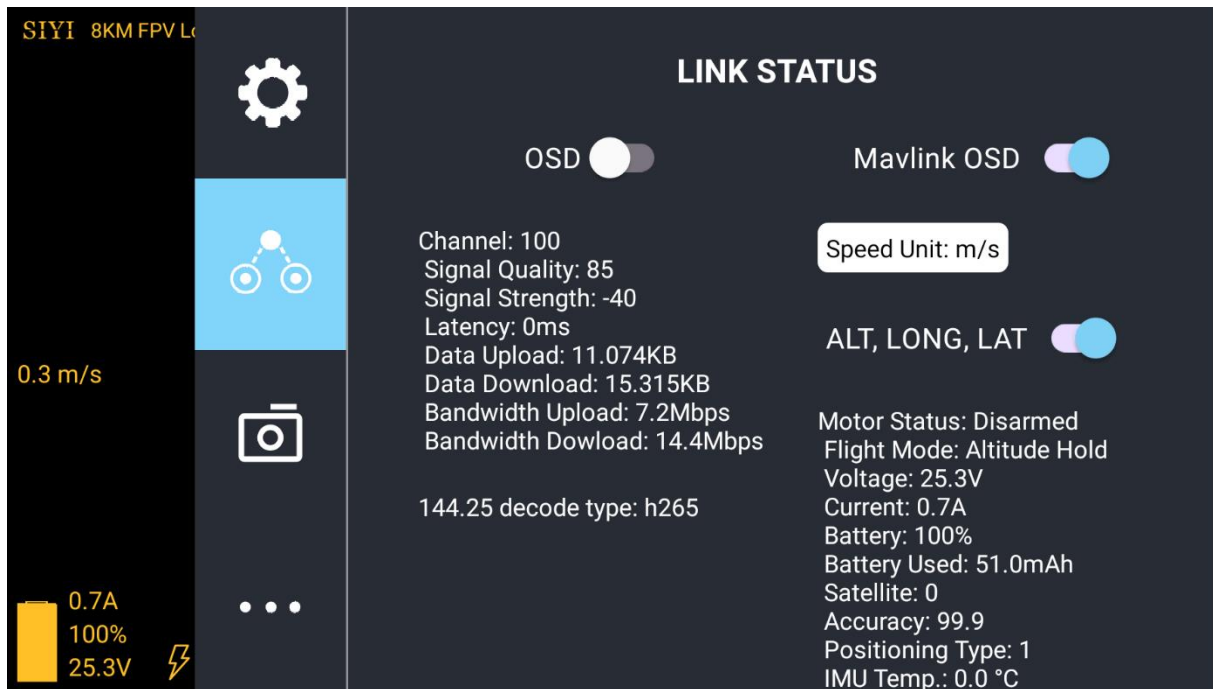

### About Link Status

OSD: Enable / disable standard OSD information.

Mavlink OSD: Enable / disable Mavlink OSD information.

Speed Unit: Switch speed unit between meter per seconds and kilometer per hour.

Longitude and Latitude: Enable / disable information.

## 5.3 Gimbal Camera

Configure the basic functions for SIYI gimbal cameras and cameras.

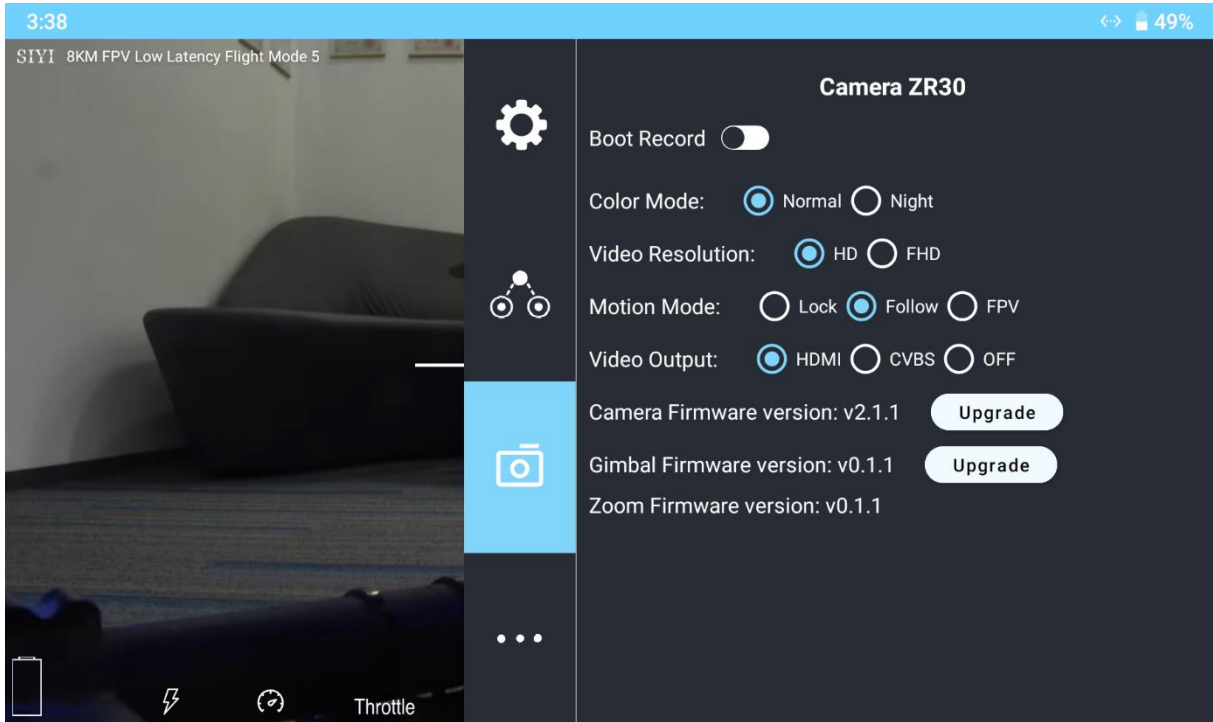

### About Gimbal Camera

**Auto Record:** Turn on / off automatically video recording by TF card on gimbal camera start.

**Record Resolution:** Switch camera record resolution between HD (720p), Full HD (1080p), 2K, and 4K.

**Gimbal Working Mode:** Switch gimbal working mode among Lock Mode, Follow Mode, and FPV Mode.

- **Lock Mode:** Horizontally, gimbal does not follow when aircraft rotates.
- **Follow Mode:** Horizontally, gimbal follows when aircraft rotates.
- **FPV Mode:** Gimbal rotates simultaneously as aircraft rolls to get FPV view, and output enhanced stable images.

Camera Firmware Version: Display current camera firmware version.

Gimbal Firmware Version: Display current gimbal firmware version.

Zoom Firmware Version: Display current gimbal firmware version.

## 5.4 About SIYI FPV

Displays the software version of SIYI FPV and common contact information of SIYI Technology.

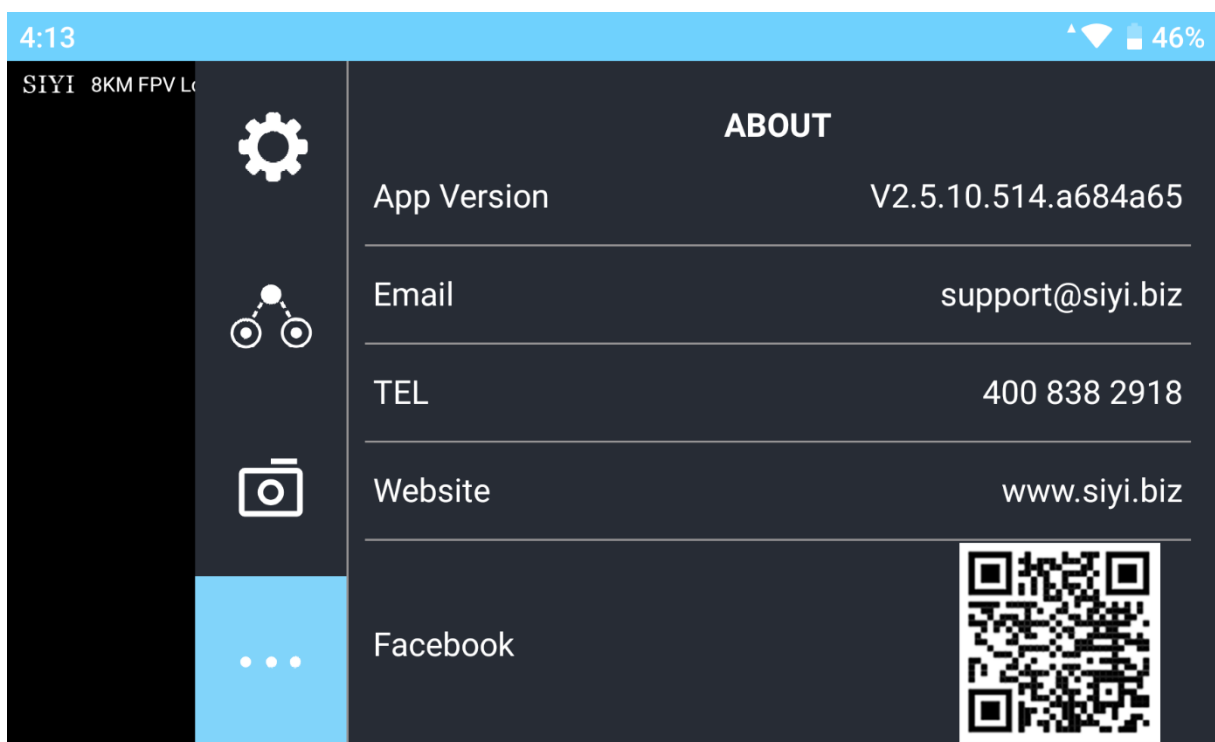

## 6 Firmware Upgrade and Configuration

SIYI PC Assistant is a Windows software developed by SIYI to configure almost all SIYI devices for remote controller channels settings, firmware update, and gimbal camera configuration.

### **Mark**

The manual is edited based on SIYI PC Assistant v1.3.2.

### 6.1 Gimbal / Zoom Firmware Update

SIYI gimbal camera can be connected to SIYI PC Assistant for gimbal firmware and zoom firmware update.

Before upgrading, it is necessary to prepare the tools, software, and firmware below.

- SIYI PC Assistant (v1.3.2 or latest version)
- Gimbal Firmware
- Zoom Firmware

 **Mark**

Above software and firmware can be downloaded from relevant product page on SIYI Official Store (<https://shop.siyi.biz>).

- Cable (USB-C to USB-A)

 **Mark**

Customers should prepare the above tools.

### **Firmware Upgrade Steps**

1. Install “SIYI PC Assistant” on your Windows device.
2. Use the USB-C to USB-A cable to connect Windows device’s USB-A port to gimbal camera’s USB-C port.
3. Run “SIYI PC Assistant” and switch to “Upgrade” page to check gimbal camera’s current gimbal firmware version.

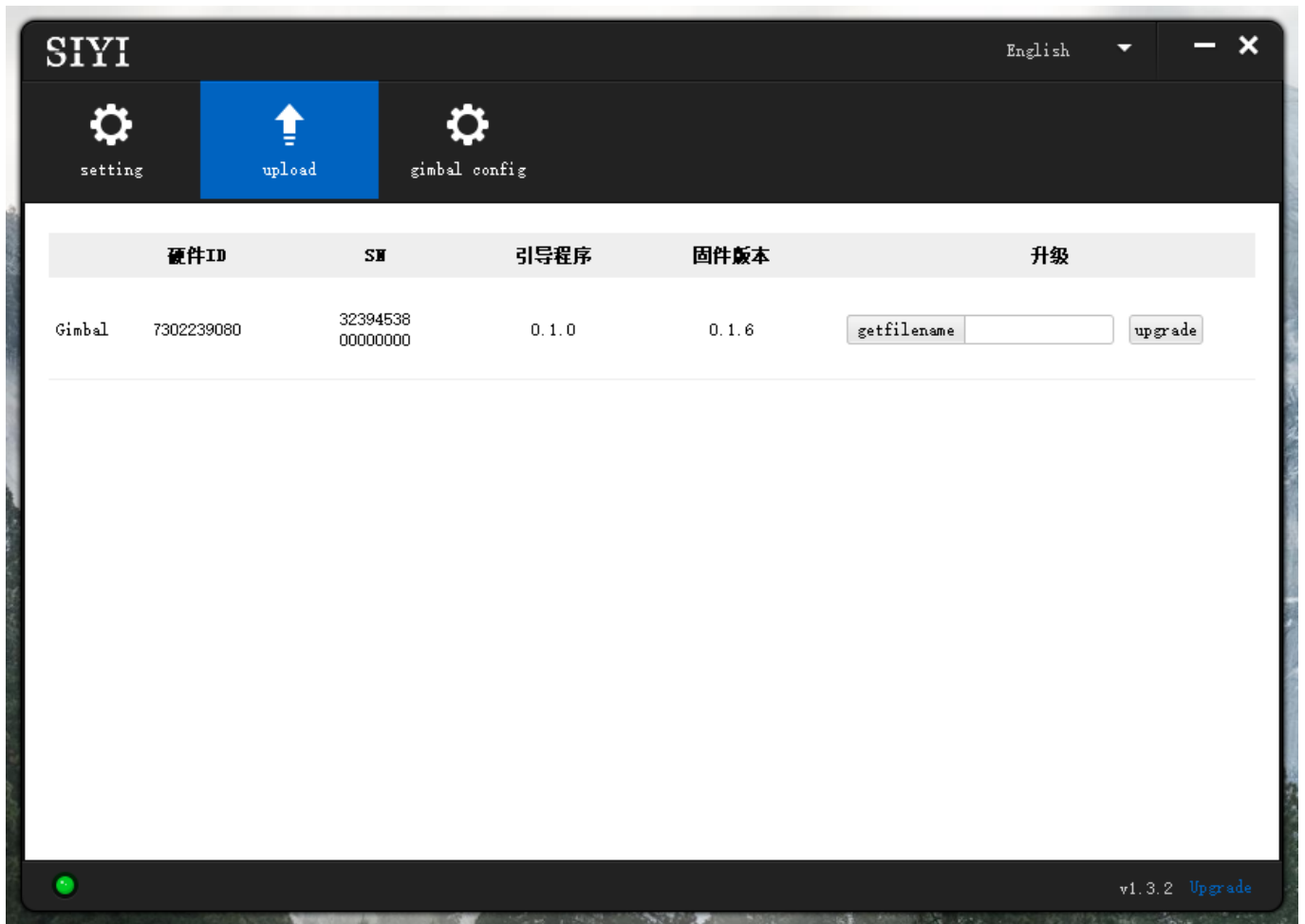

- If gimbal firmware is not latest, then click the “Select File” button in the “Gimbal” to import the latest firmware. And click “Upgrade” and wait till it is “100%” finished.
- Above steps can be repeated for the zoom firmware as well.

**Mark**

Before updating any firmware, gimbal camera should be powered.



## 6.2 Camera Firmware Update

The camera firmware of SIYI gimbal can be upgraded by SD / TF card for camera firmware.

Before upgrading, it is necessary to prepare below tools, software, and firmware below.

- SD / TF card

### Mark

Customers should prepare the above tools.

- Camera Firmware

### Mark

Above software and firmware can be downloaded from relevant product page on SIYI Official Store (<https://shop.siyi.biz>).

## Firmware Upgrade Steps

1. Save camera firmware's ".bin" file to the SD / TF card's root directory and do not change the file name.

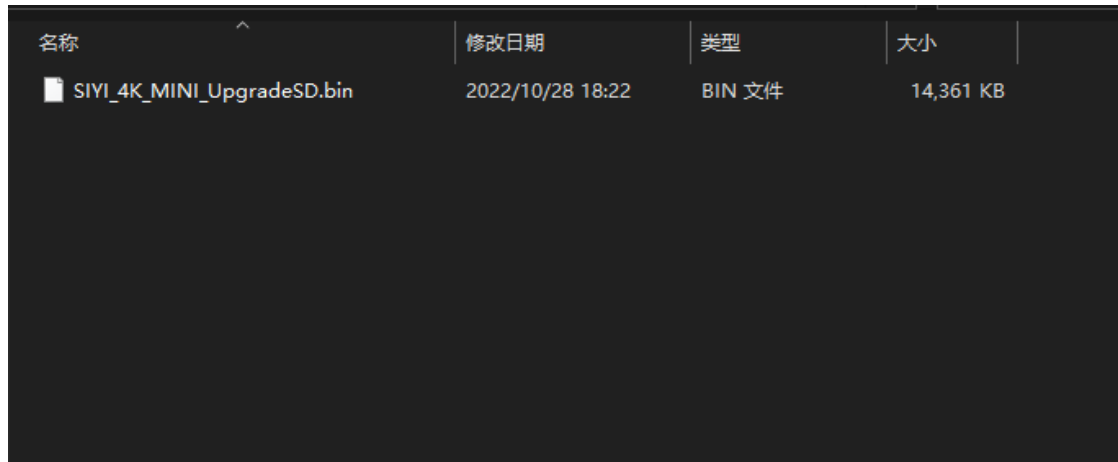

2. Restart gimbal camera and wait for 3 to 5 minutes. Camera firmware will be flashed automatically.
3. Run SIYI FPV app or SIYI PC Assistant software to check if camera firmware is updated successfully.

## 6.3 Gimbal Camera Configuration

SIYI gimbal camera can be connected to SIYI PC Assistant for channel settings and camera settings.

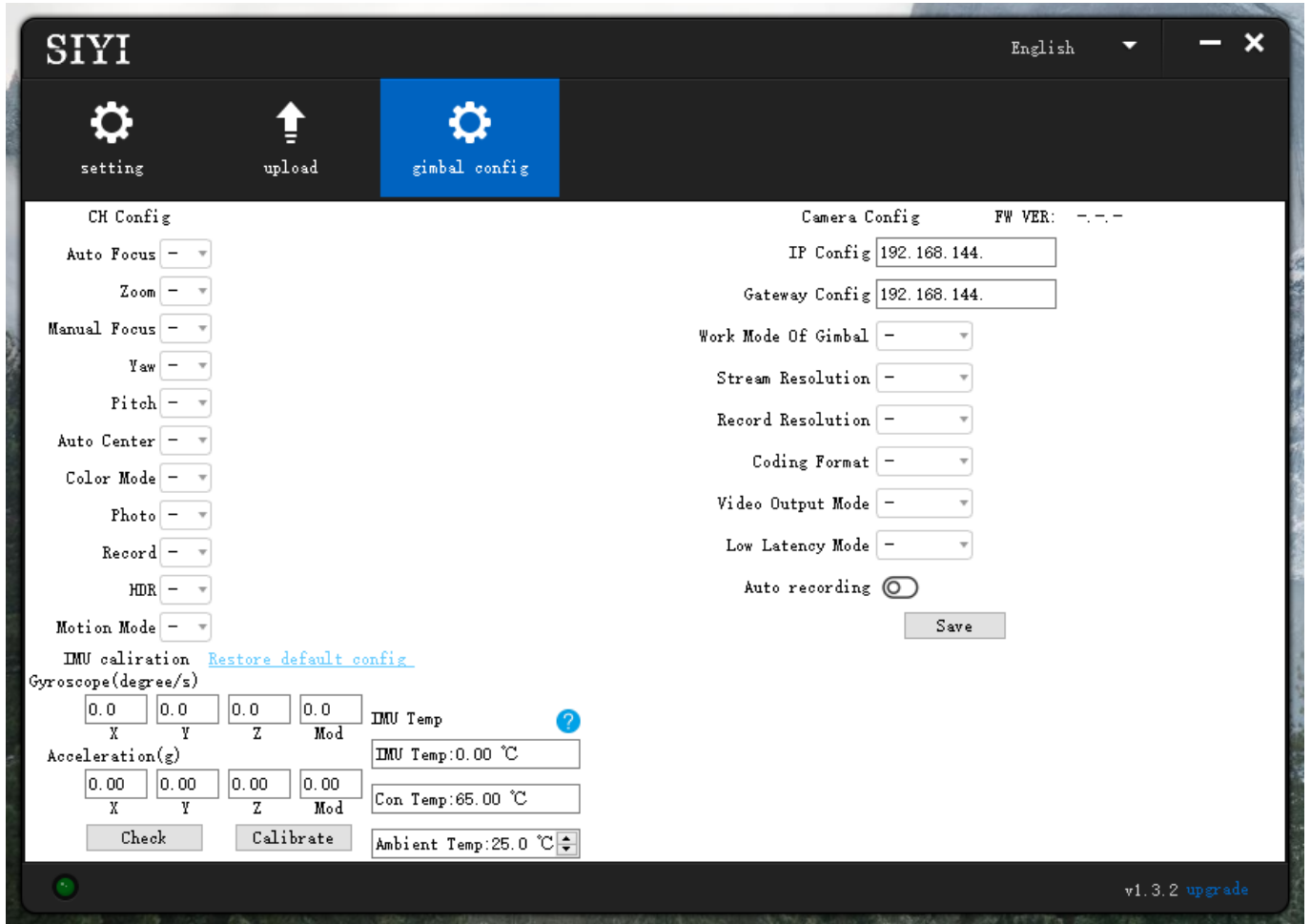

### 6.3.1 Channel Settings

The “Channel Config” menu under “Gimbal Config” menu can config the below gimbal camera functions to up to 16 channels and an idle channel (disabled).

- Auto Focus
- Zoom
- Manual Focus
- Yaw
- Pitch
- Auto Center
- Photo
- Record
- Motion Mode

### 6.3.2 Camera Specs

The “Gimbal Config” menu also supports checking gimbal camera’s current camera firmware, switching camera resolution, and configuring camera IP addresses.

- IP Config
- Gateway Config
- Gimbal Working Mode

- Stream Resolution
- Record Resolution
- Coding Format
- Video Output Mode
- Low Latency Mode
- Auto Recording

## 7 After-sale Service

If there were any questions or problems using SIYI Technology's product, you can always try to send an email to SIYI Official A/S Center ([support@siyi.biz](mailto:support@siyi.biz)) or consult your sales representative or dealer for answers or solutions.

### 7.1 Repair Service

If your purchased SIYI products cannot work properly, please contact SIYI Official A/S Center for consulting.

Usually there are two situations for acquiring repair service.

- Product Defect
- Product Damage

SIYI products under the two situations can be sent back to SIYI for repairing. Defect products with valid warranty can be repaired for free. Defect products without valid warranty or damaged products should be charged of repair fees after repairing. Please refer to SIYI's Official A/S Quotation for detail.

## 7.2 Warranty

SIYI Technology guarantees that, subject to the following conditions, Return & Refund Service, Replacement Service, and Warranty Repair Service can be requested. Please contact SIYI directly ([support@siyi.biz](mailto:support@siyi.biz) or your sales manager) or authorized SIYI dealer for more detail.

### 7.2.1 7-Day Return & Refund

You can request Return & Refund Service:

Within seven (7) days of receiving a product if the product has no manufacturing defect, has not been activated and is still in new or like-new condition.

Within seven (7) days of receiving a product if the product has a manufacturing defect.

Return & Refund Service will not be provided where:

It is requested beyond seven (7) calendar days of receiving a product.

A product sent to SIYI for Return & Refund Service does not include all original accessories, attachments or packaging, or any item is not in new or like-new condition, i.e., with cracks, dents, or scratches.

A legal proof of purchase, receipt or invoice is not provided or is reasonably believed to have been forged or tampered with.

Any fault or damage of the product is caused by unauthorized use or modification of the product, including exposure to moisture, entry of foreign bodies (water, oil, sand, etc.) or improper installation or operation.

Product labels, serial numbers, waterproof marks, etc. show signs of tampering or alteration.

Damage is caused to the product by uncontrollable external factors, including fire, floods, high winds, or lightning strikes.

A product is not delivered to SIYI within seven (7) calendar days after Return & Refund Service confirmation is sent from SIYI.

Other circumstances stated in this policy.

## **7.2.2 15-Day Replacement**

You can request Replacement Service:

Within fifteen (15) calendar days of receiving the product if the product has sustained a substantial damage in transit, provided always that the damage proof issued by the carrier can be provided to SIYI.

Within fifteen (15) calendar days of receiving the product if the product does not match the original description of the product in one or more significant respects.



Within fifteen (15) calendar days of receiving the product if the product suffers performance failure.

Replacement Service will not be provided where:

Service is requested more than fifteen (15) calendars days after receiving a product.

Legal proof-of-purchase, receipts, or invoices are not provided, or are reasonably believed to have been forged or tampered with.

A product sent to SIYI for replacement does not include all original accessories, attachments, and packaging, or contains items damaged by user error.

A product is found to have no defects after all appropriate tests are conducted by SIYI.

Any fault or damage of the product is caused by unauthorized use or modification of the product, including exposure to moisture, entry of foreign bodies (water, oil, sand, etc.) or improper installation or operation.

Damage is caused by uncontrollable external factors, including fires, floods, high winds, or lightning strikes.

Received product has not been sent back to SIYI seven (7) calendar days after replacement confirmation from SIYI.

Proof of damage during transit issued by the carrier cannot be provided.

Other circumstances stated in this policy.

### 7.2.3 1-Year Warranty Repair

You can request warranty repair service:

If a product does not function as warranted during the warranty period, you may obtain after-sales service by contacting SIYI's service center. You will need to provide a valid proof-of-purchase, receipt, or order number for the warranty service.

Charges may apply for services not covered by this Limited Warranty. Please contact SIYI for information specific to your location.

Please note that the warranty service is only available in the respective SIYI service regions where you purchased your SIYI product.

Warranty Repair service will not be provided where:

Crashes or fire damage caused by non-manufacturing factors, including but not limited to pilot errors.

Damage caused by unauthorized modification, disassembly, or shell opening not in accordance with official instructions or manuals.

Damage caused by improper installation, in correct use, or operation not in accordance with official instructions or manuals.

Damage caused by non-authorized service provider.

Damage caused by unauthorized modification of circuits and mismatch or misuse of the battery and charger.

Damage caused by operation in bad weather (i.e., strong winds, rain, sand/dust storms, etc.)

Damage caused by operating the product in an environment with electromagnetic interference (i.e., in mining areas or close to radio transmission towers, high-voltage wires, substations, etc.)

Damage caused by operating the product in an environment suffering from interference from other wireless devices (i.e., transmitter, video-downlink, Wi-Fi signals, etc.)

Damage caused by reliability or compatibility issues when using unauthorized third-party parts.

Damage caused by operating the unit with a low-charged or defective battery.

Products or parts with an altered identification label or from which the identification label has been removed.

**SIYI Technology (Shenzhen) Co., Ltd**

Business Inquiry: [info@siyi.biz](mailto:info@siyi.biz)

Phone: +86 400 838 2918

A/S Center: [support@siyi.biz](mailto:support@siyi.biz)